

Rasant SPEED



HOCHAUFLÖSENDE BILDER DER BAUSCHRITTE
HIGH-RESOLUTION IMAGES OF THE CONSTRUCTION STEPS
IMAGES À HAUTE RÉOLUTION DES ÉTAPES DE CONSTRUCTION



EP-Version Nr.: 2684



GP-Version Nr.: 2685

www.robbe.com



V2_6/2022

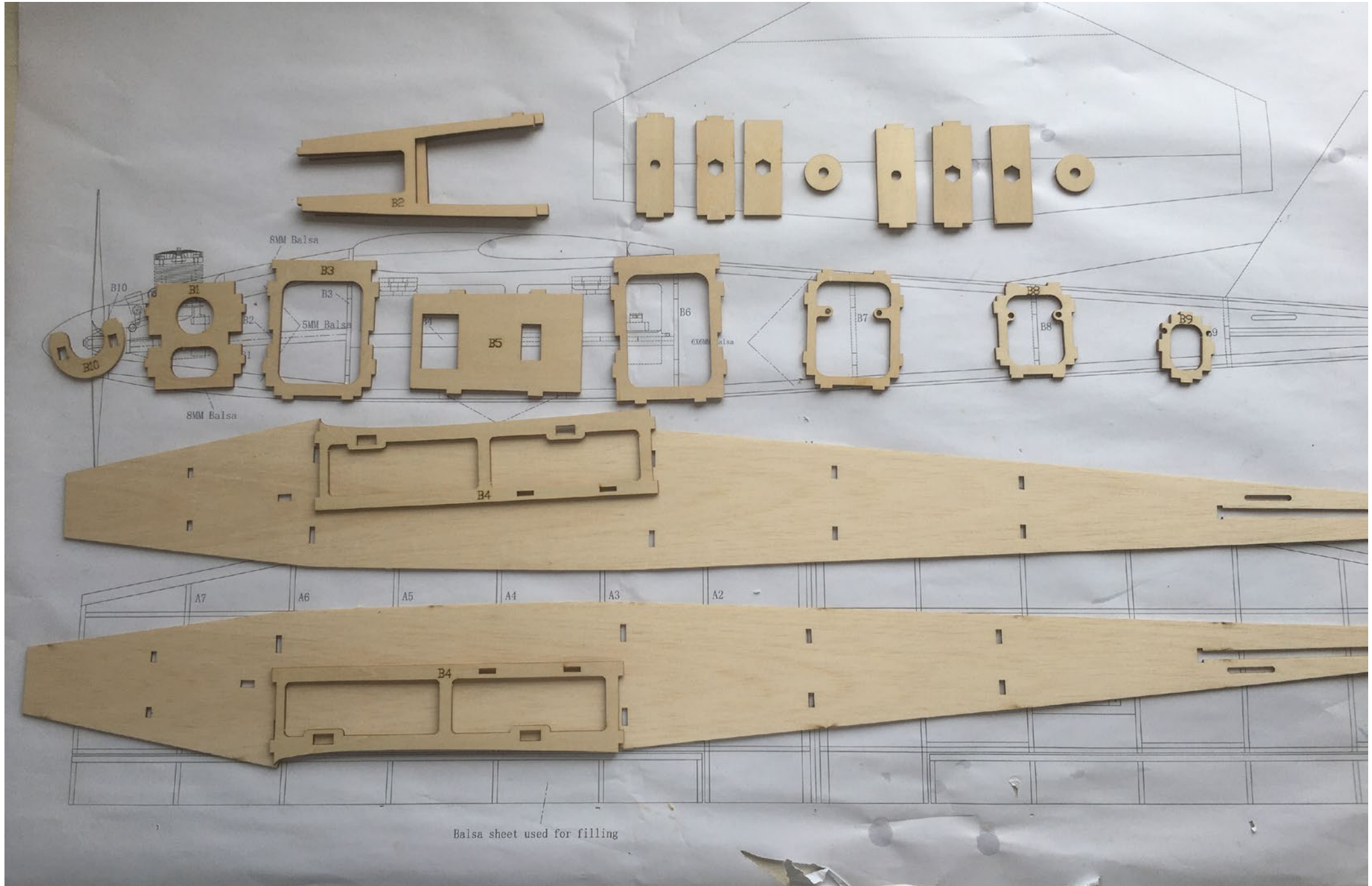

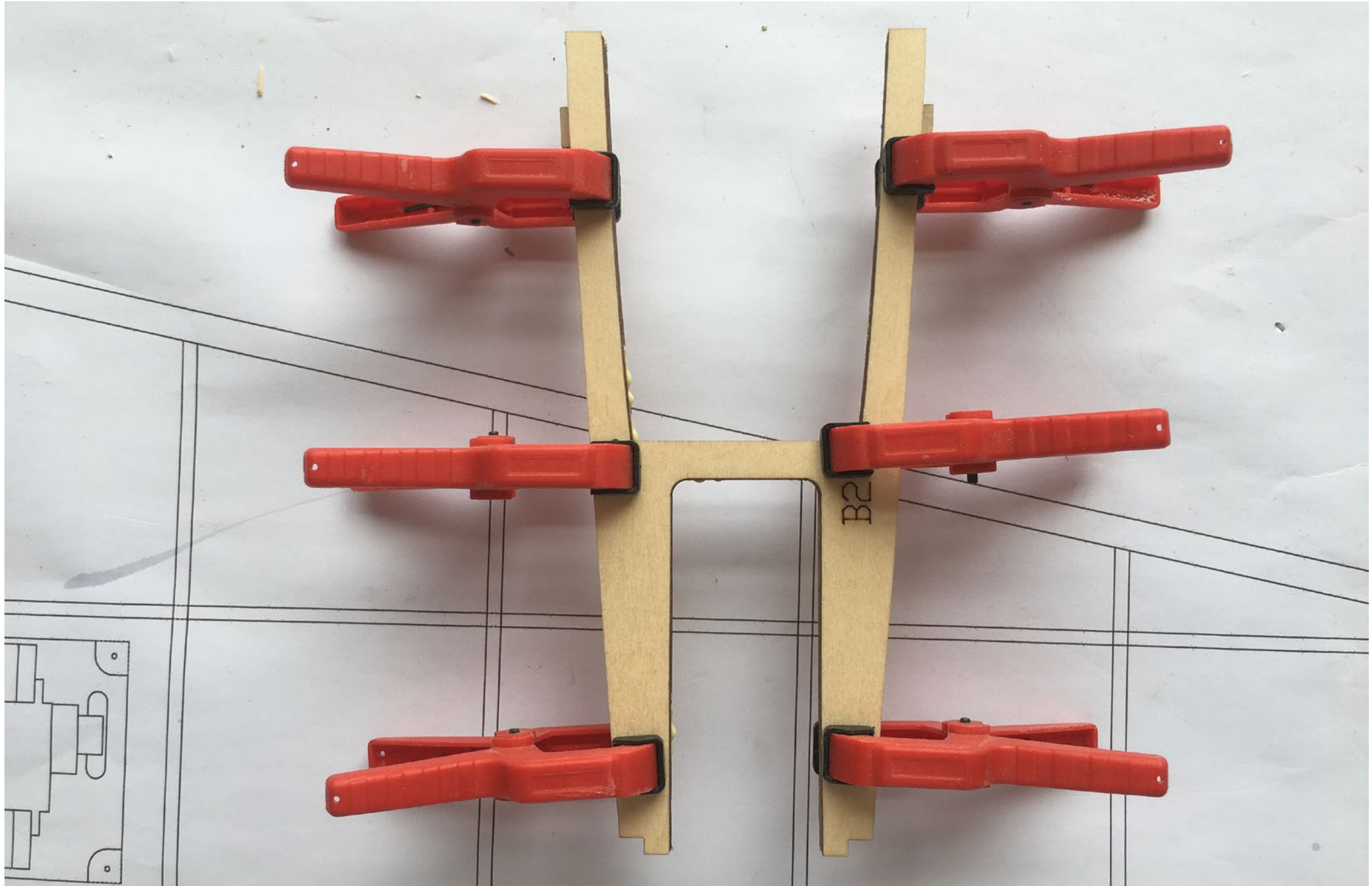

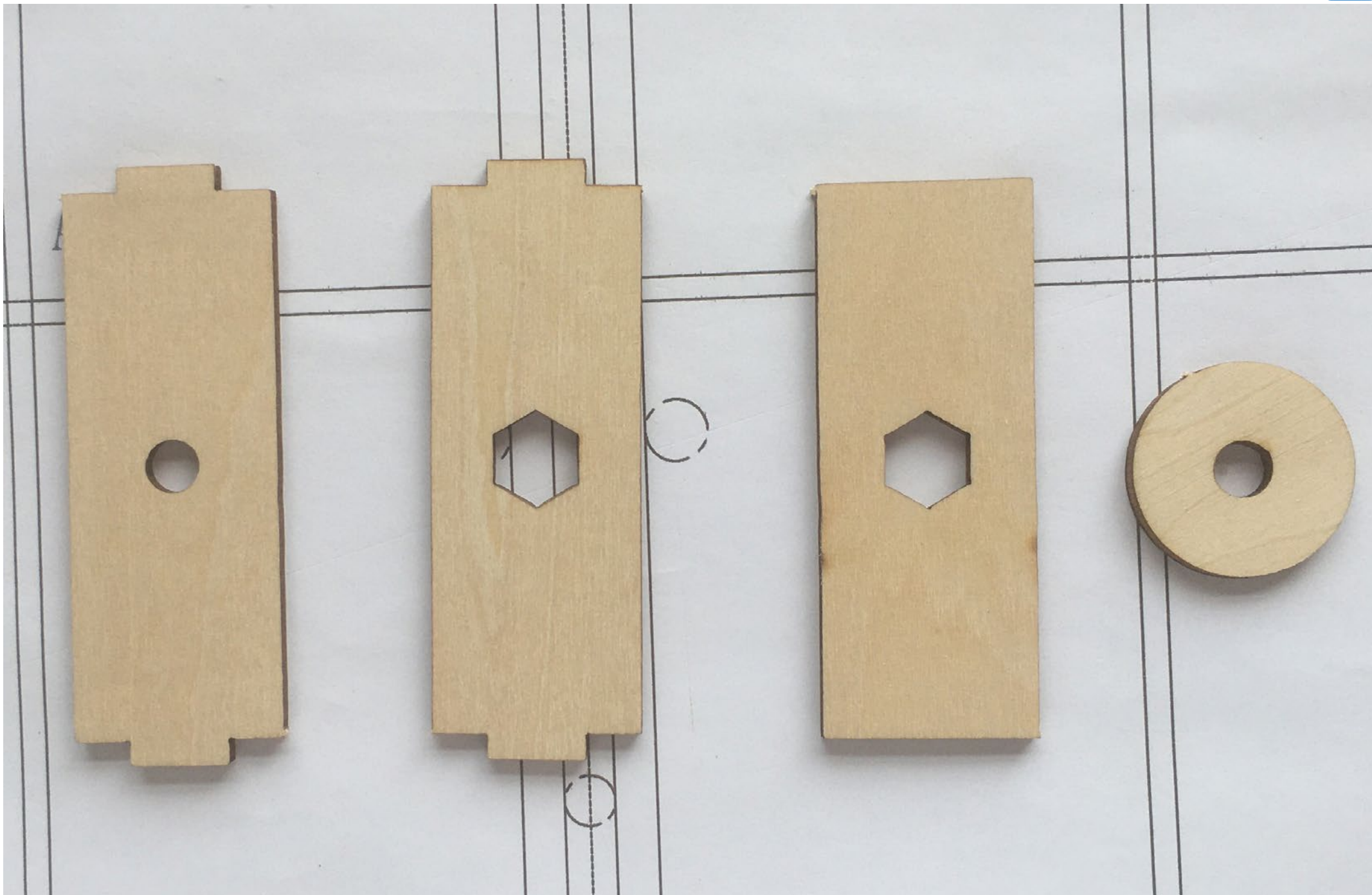

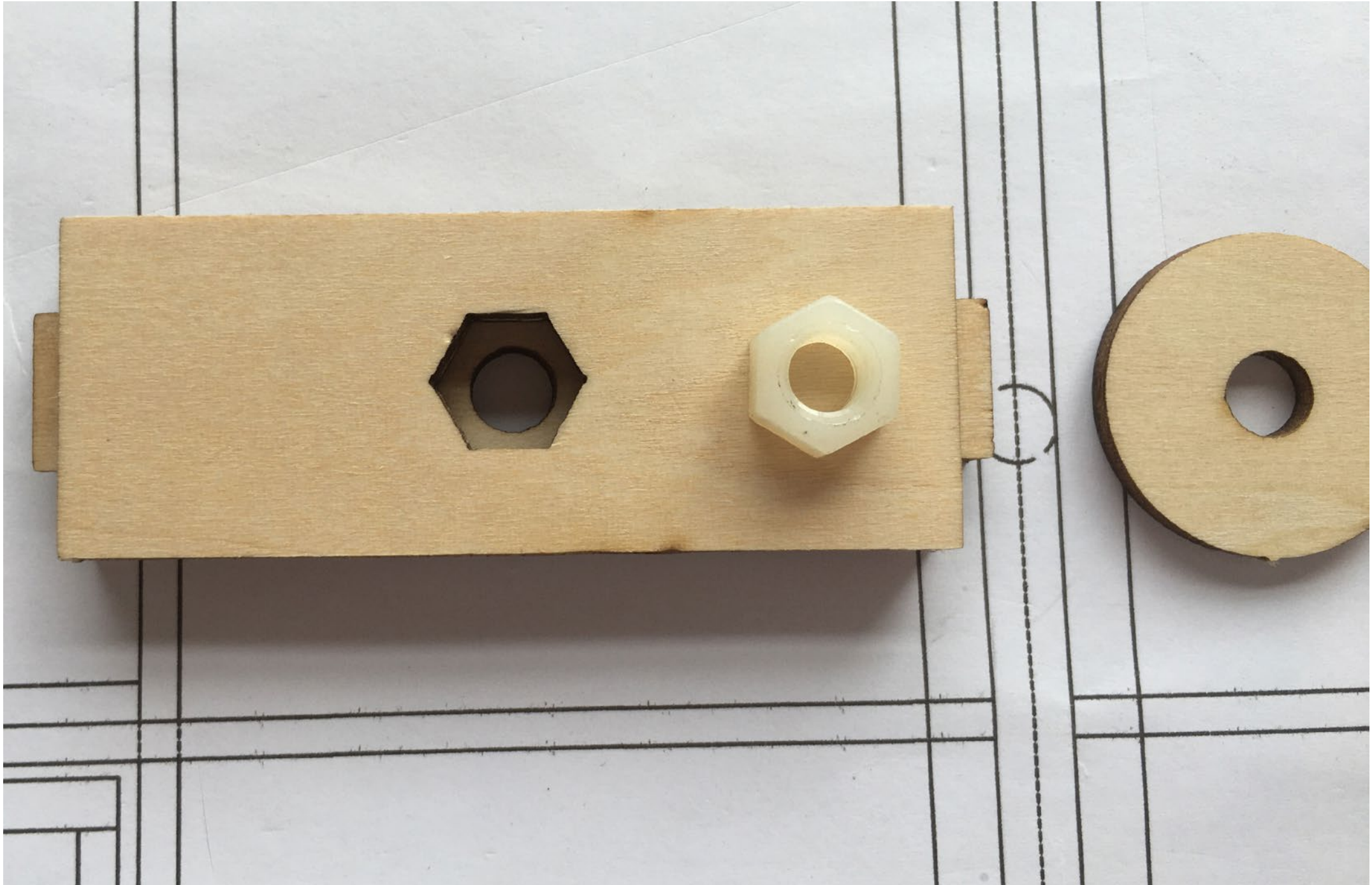

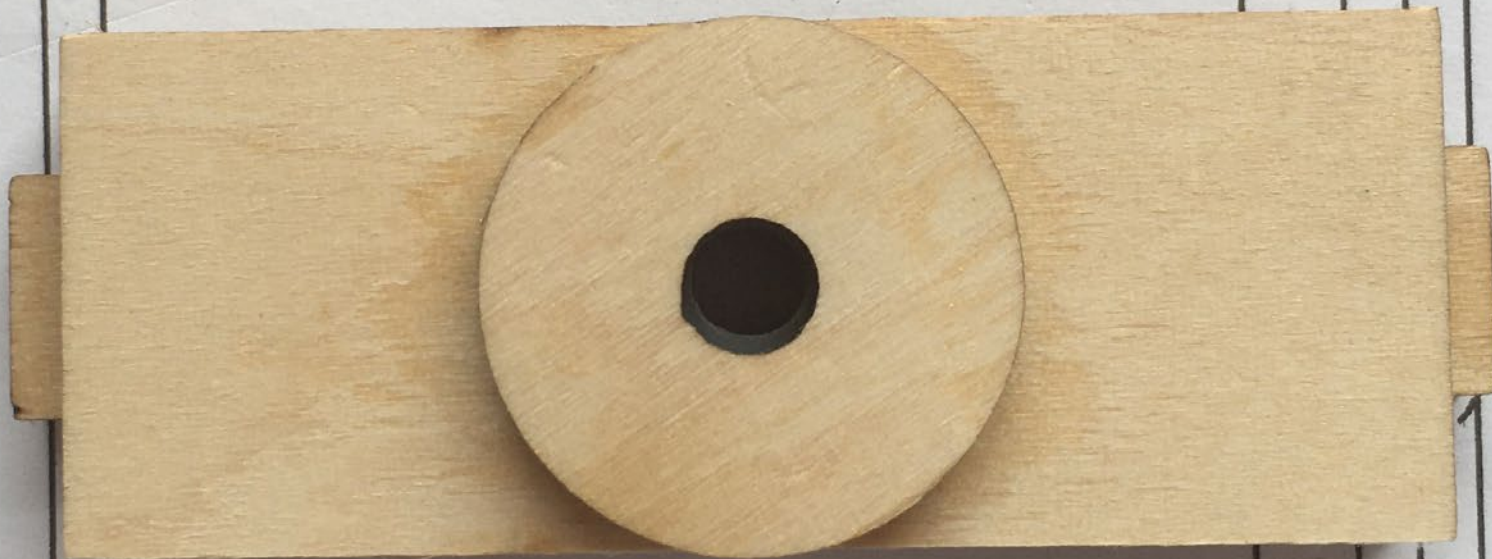

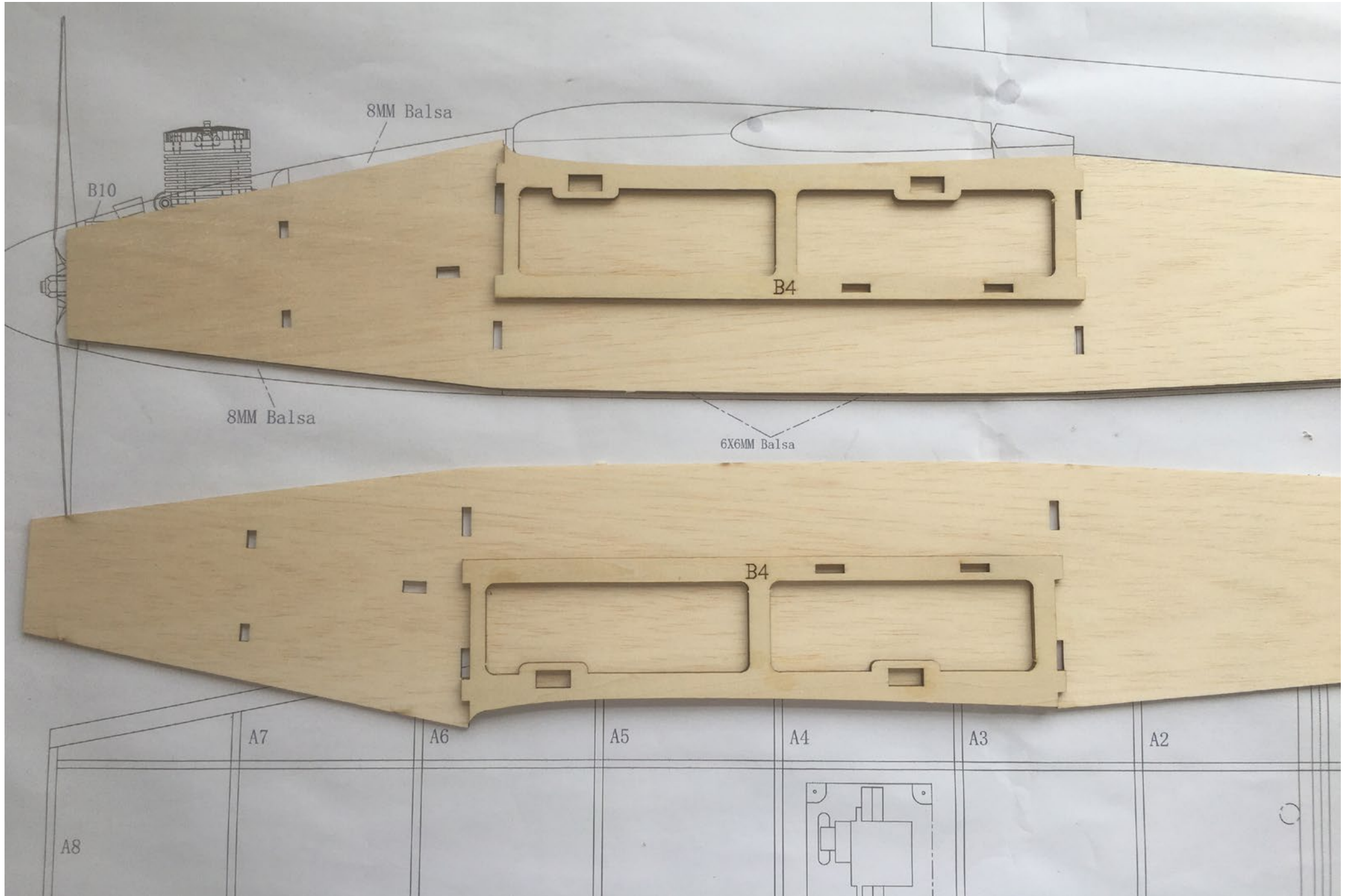

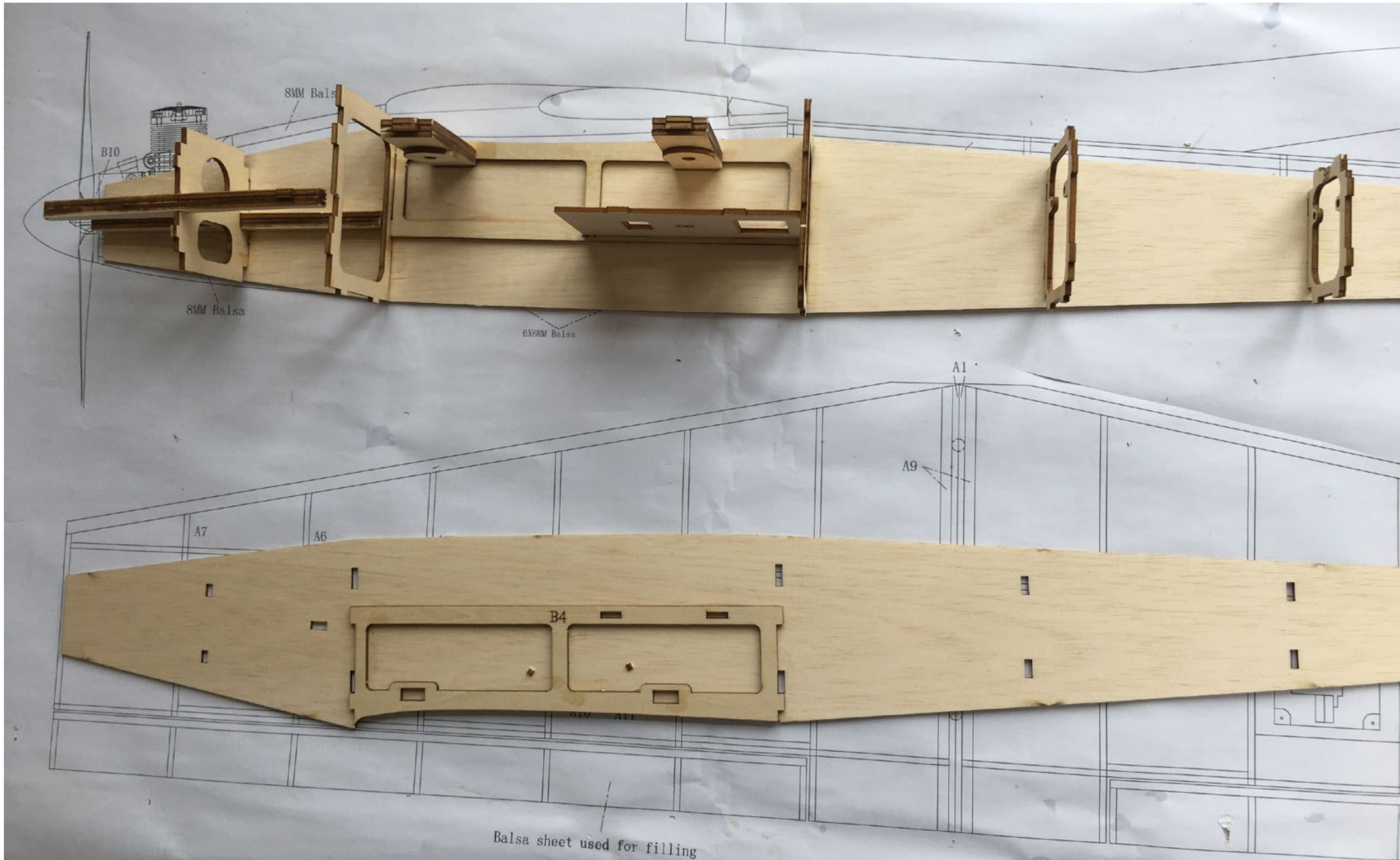

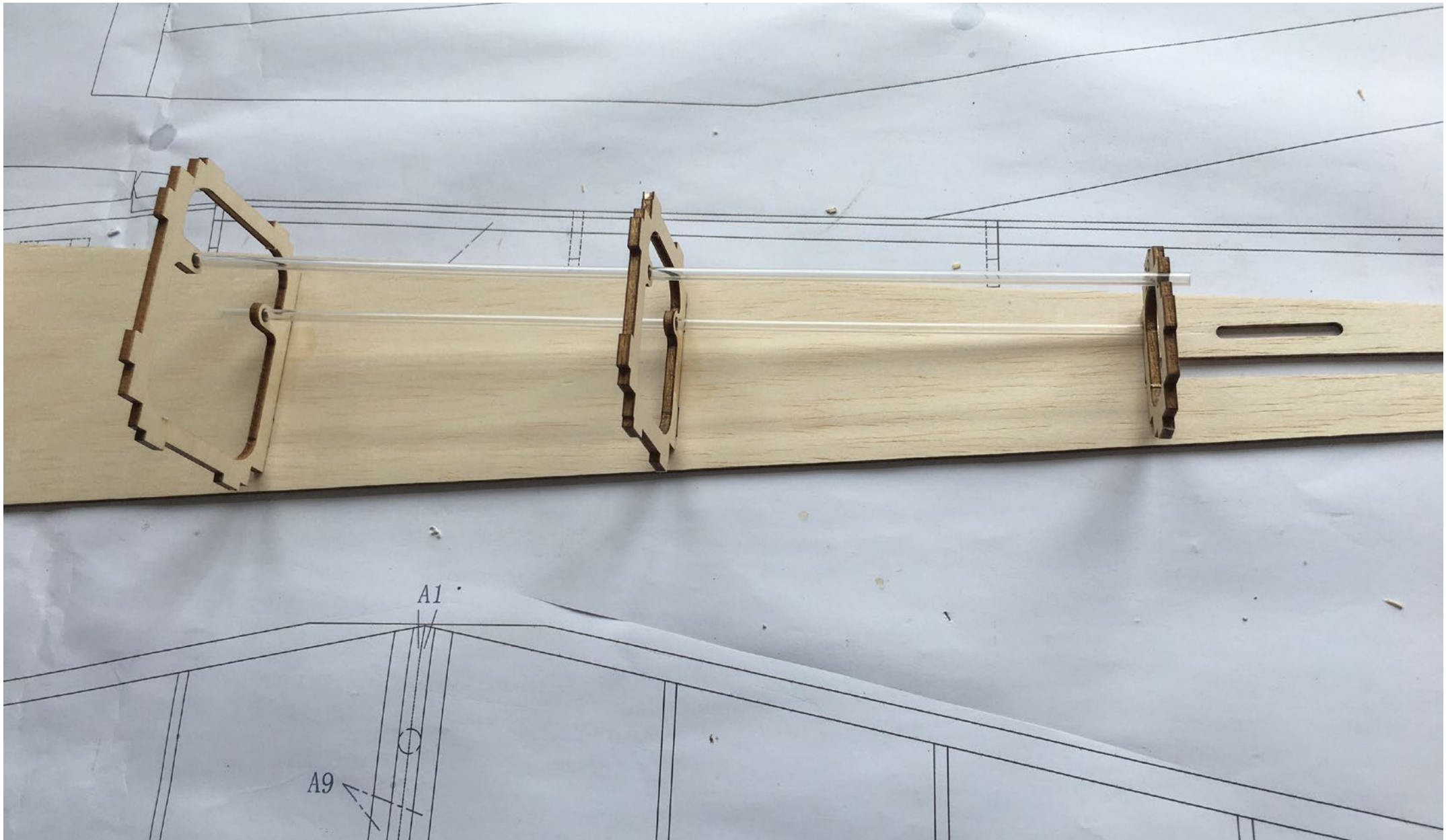

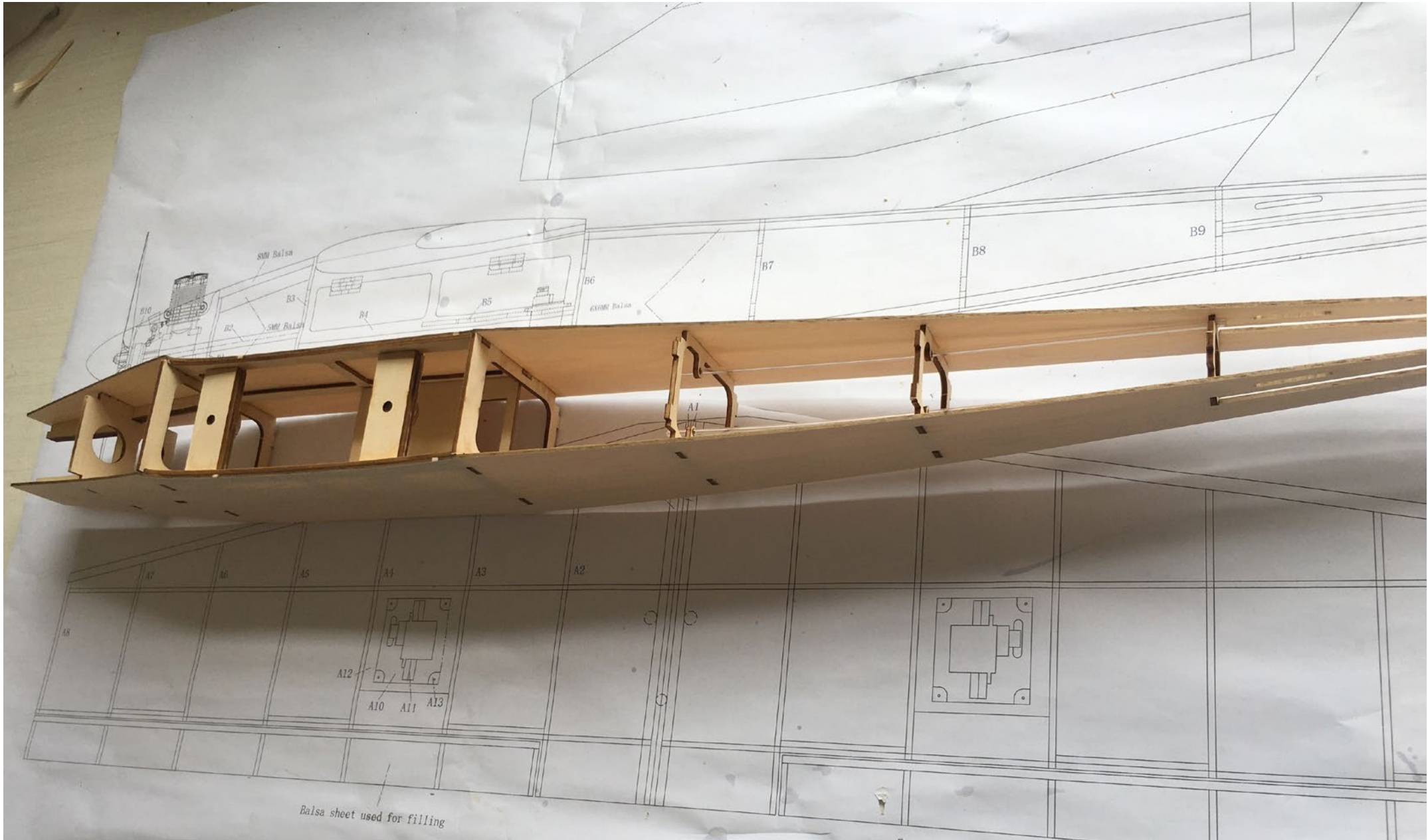

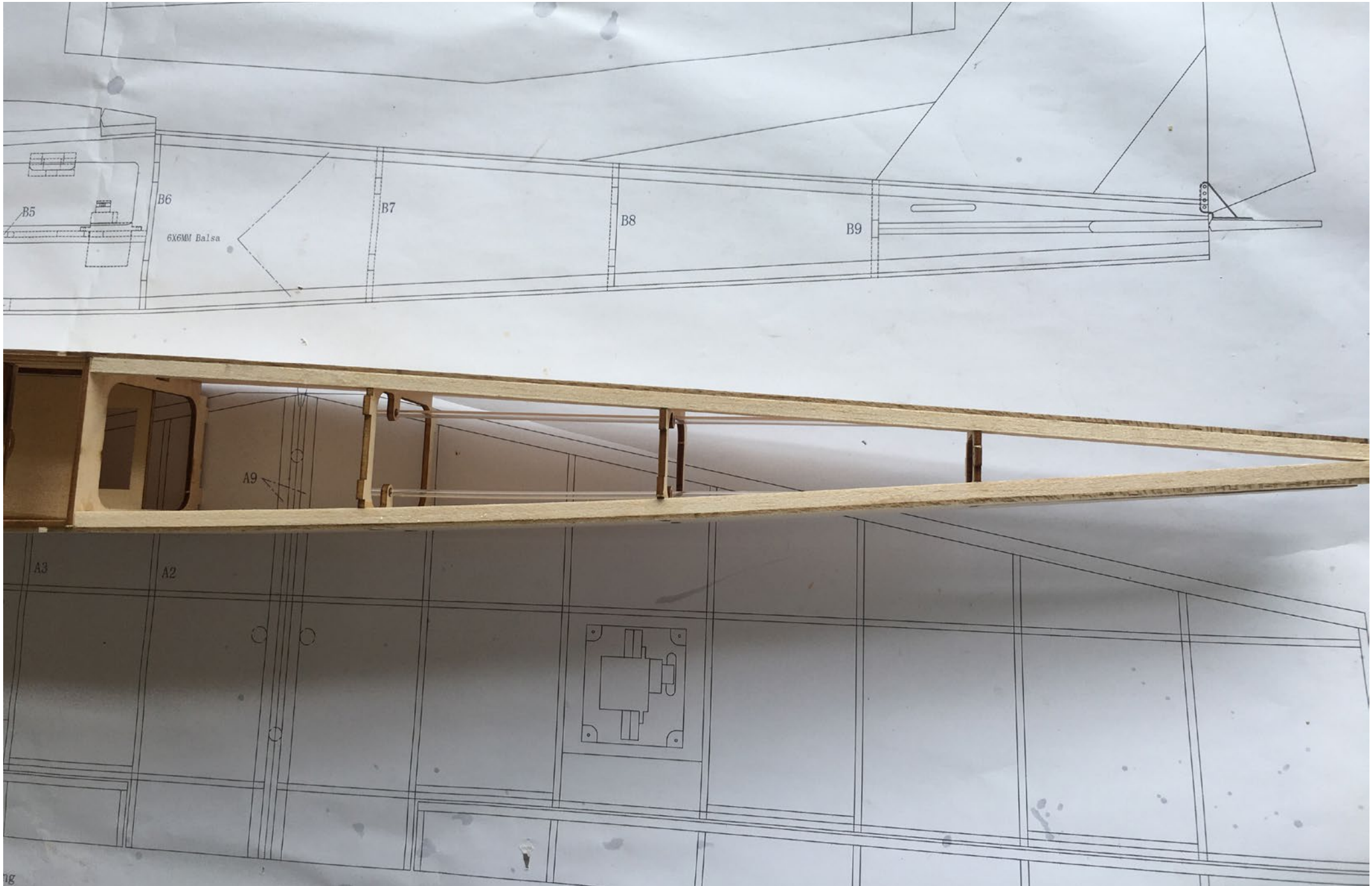

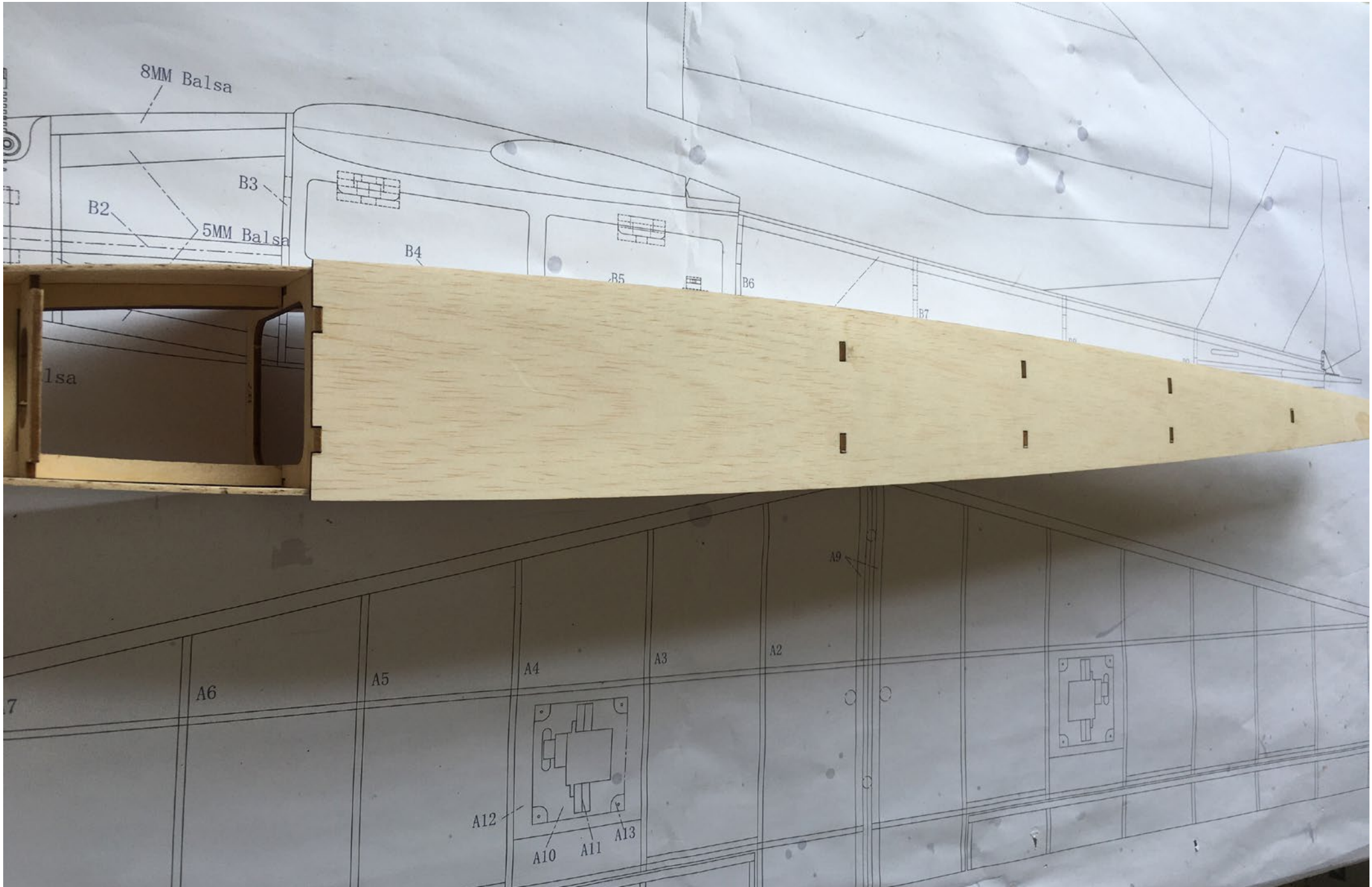













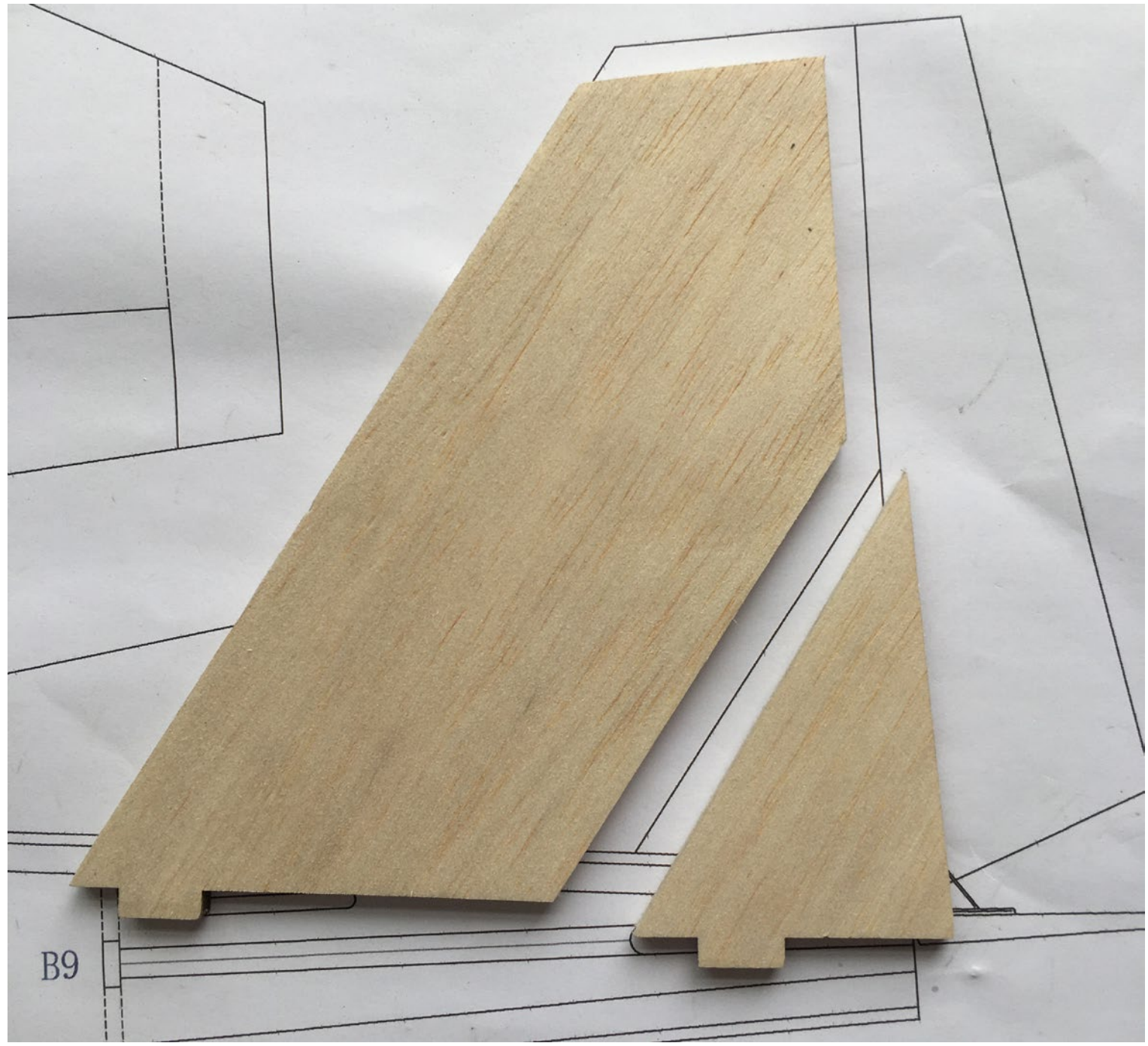

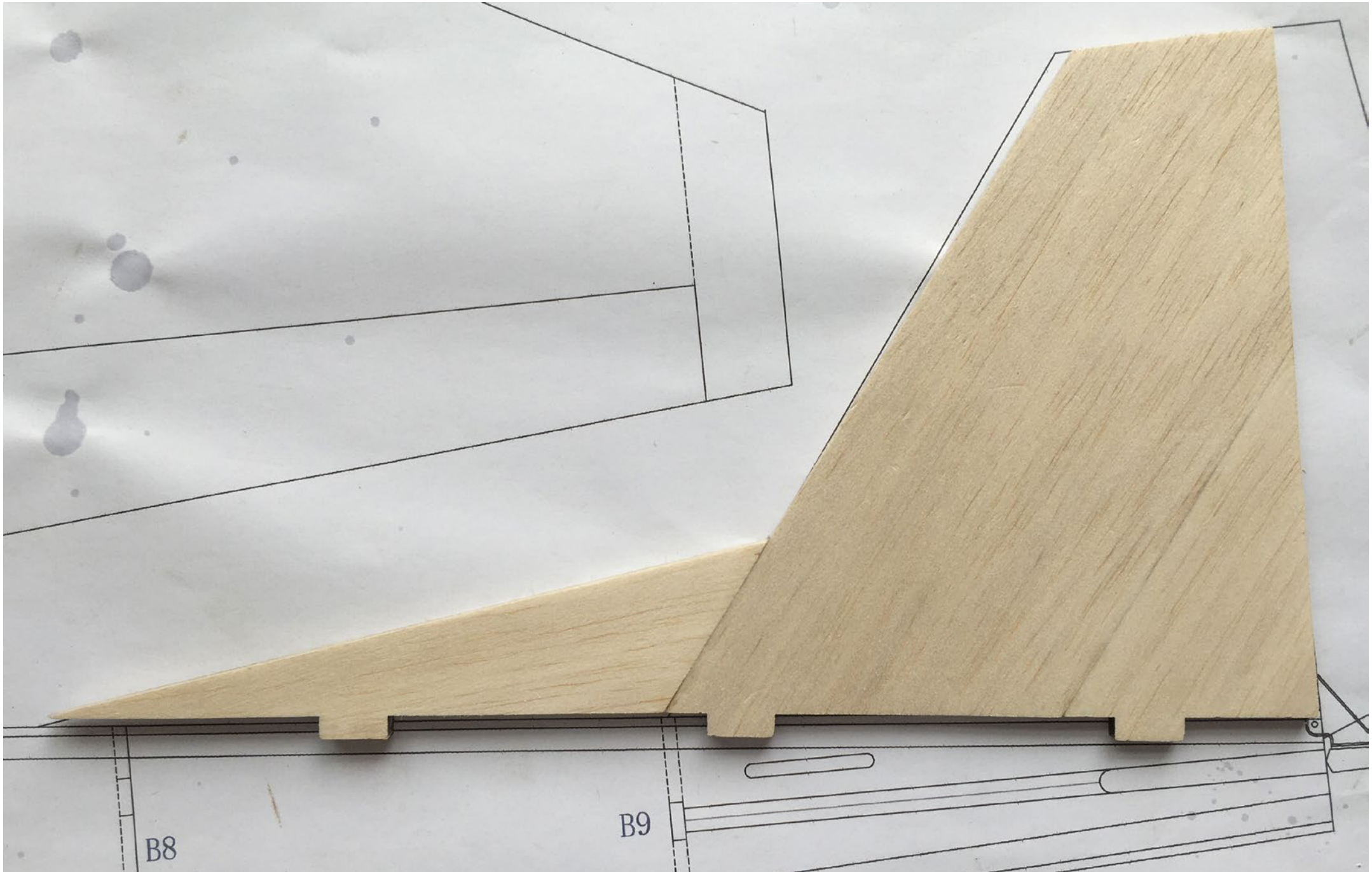

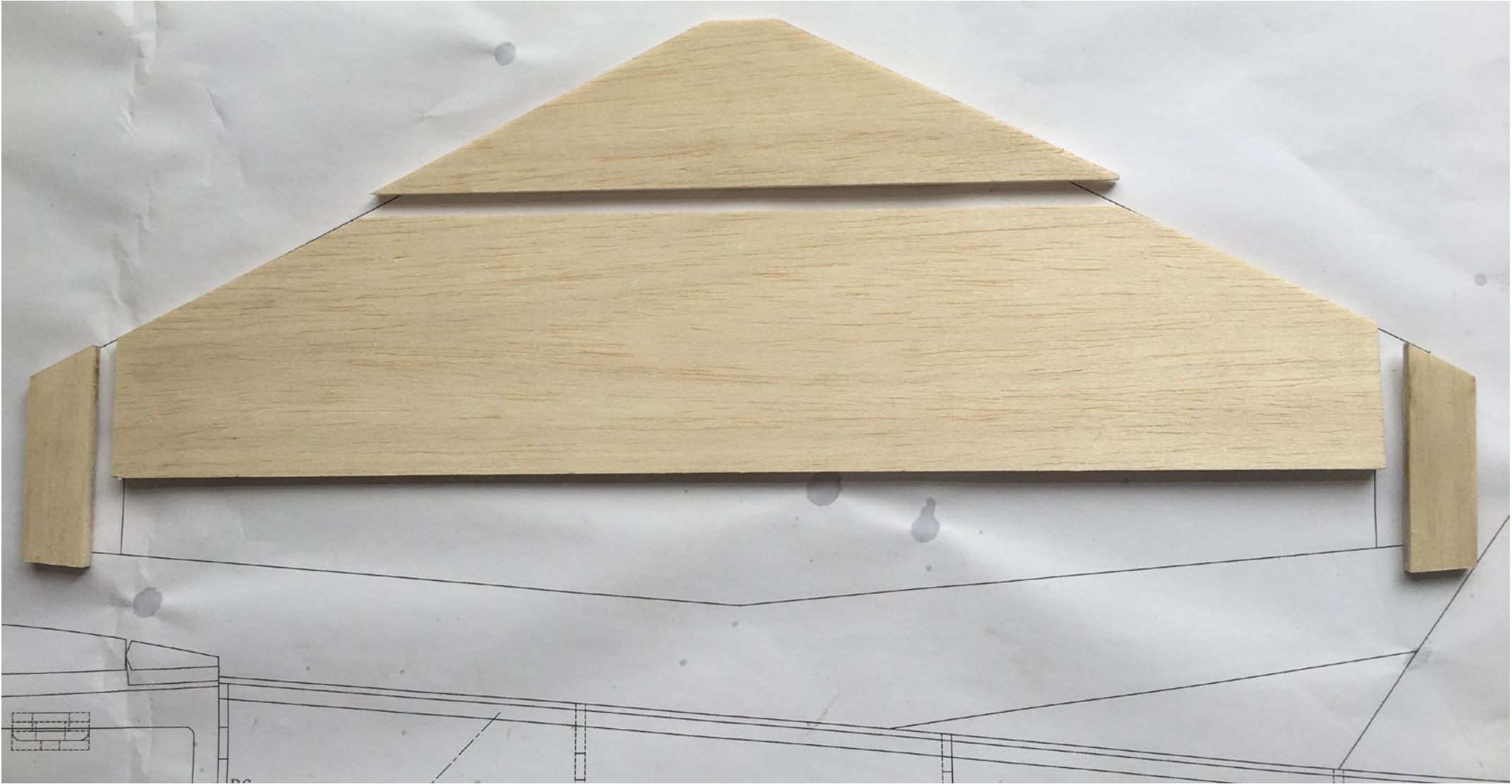



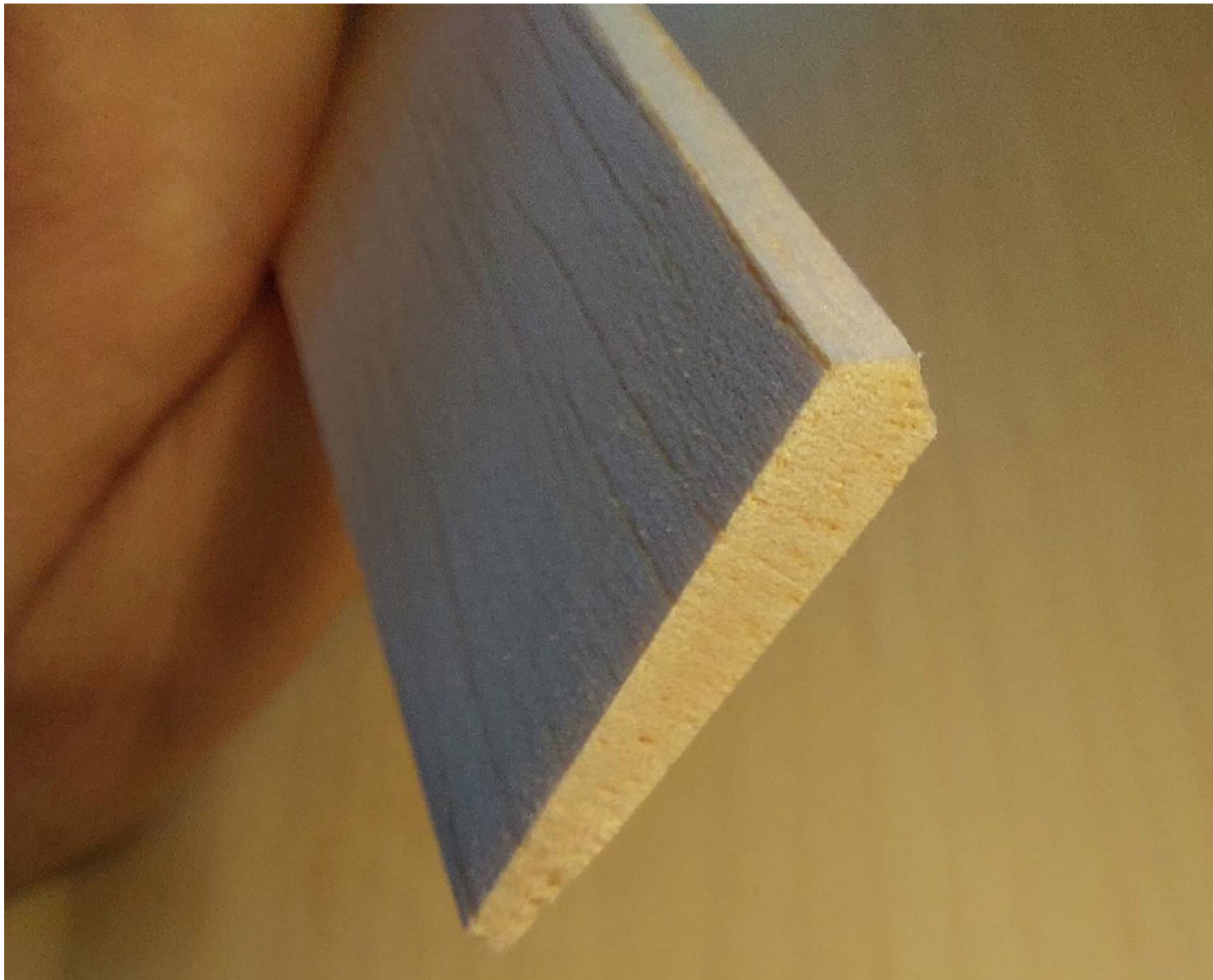



← **robbe**

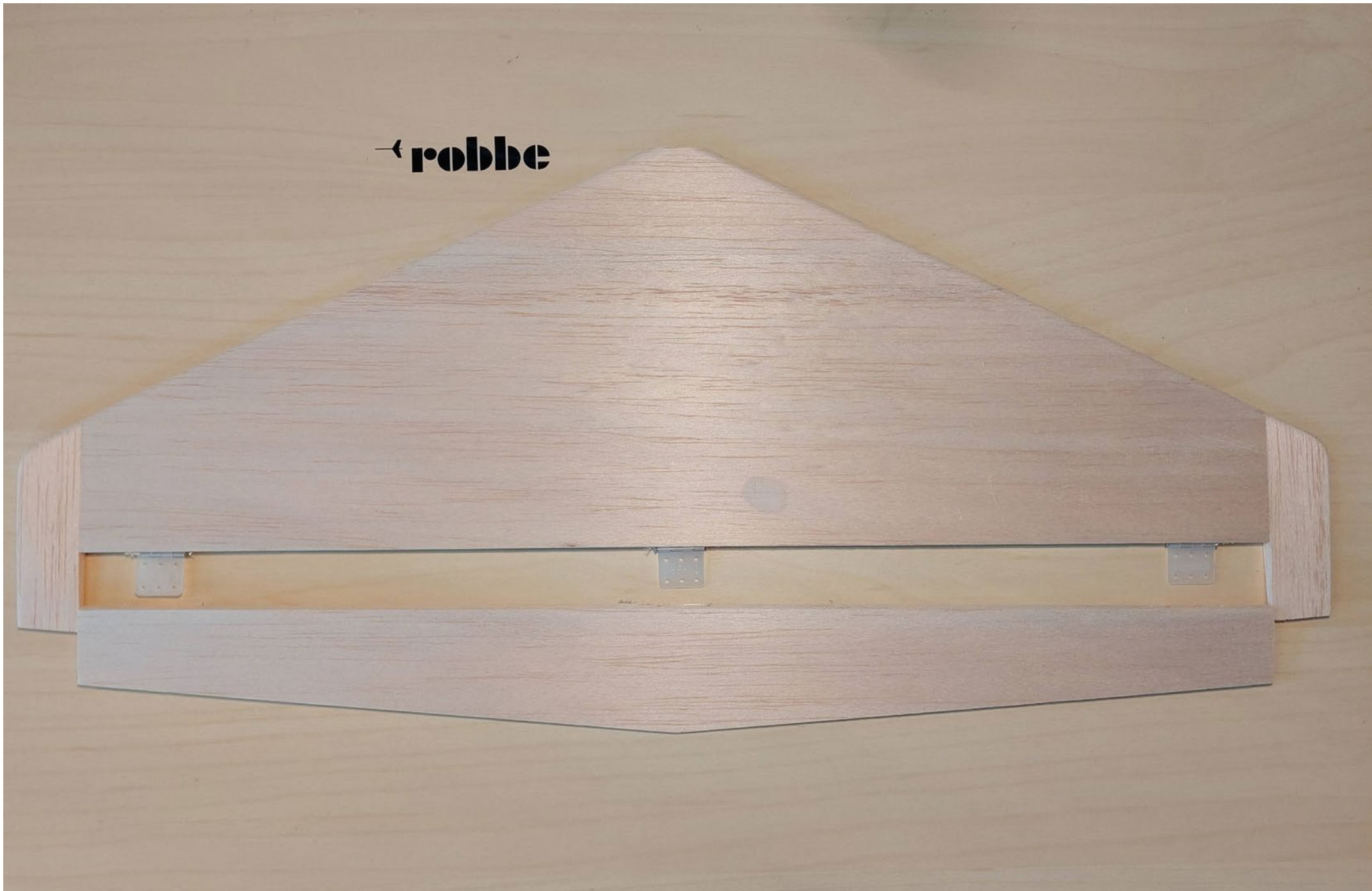



← **robbe**







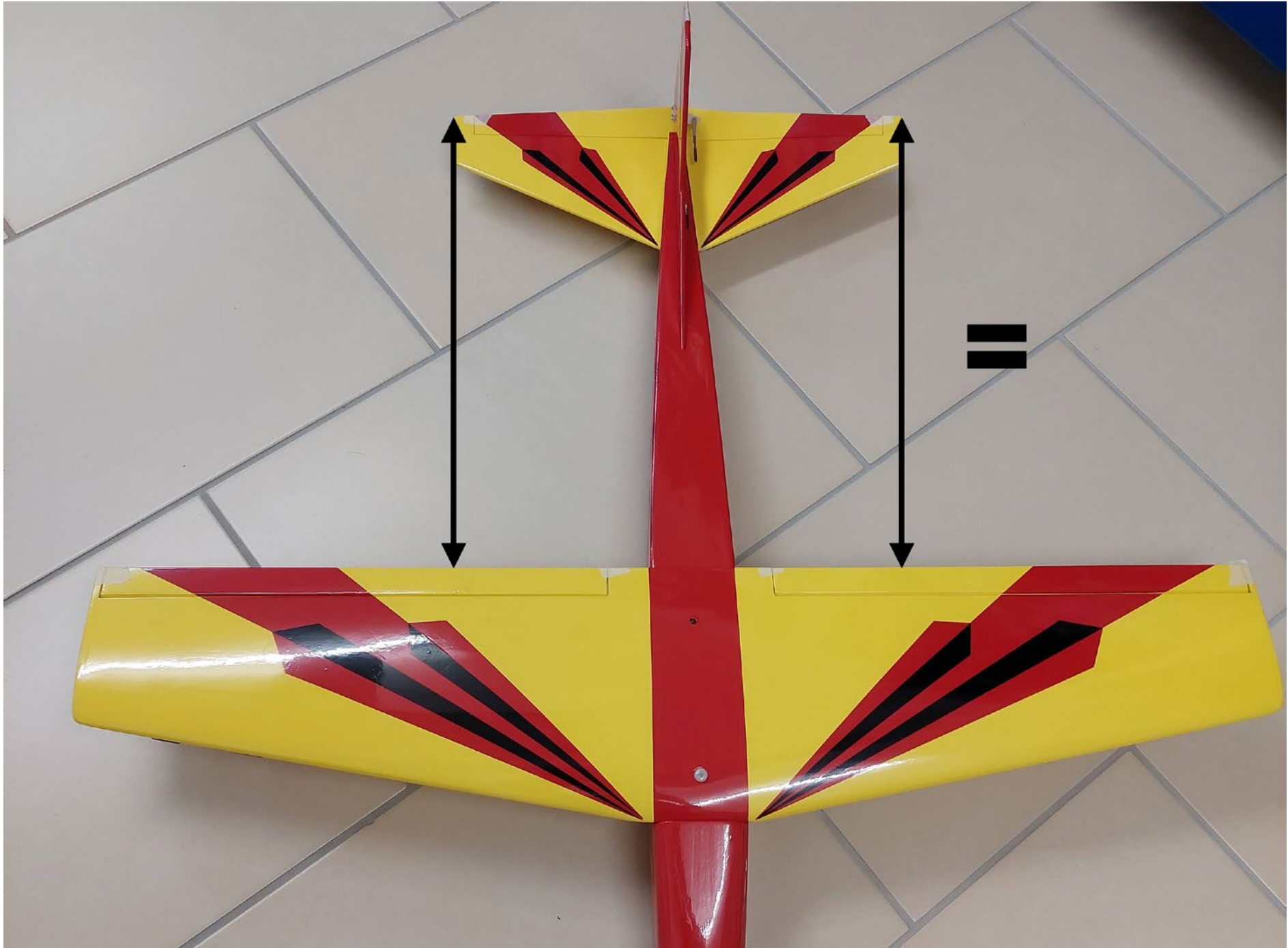

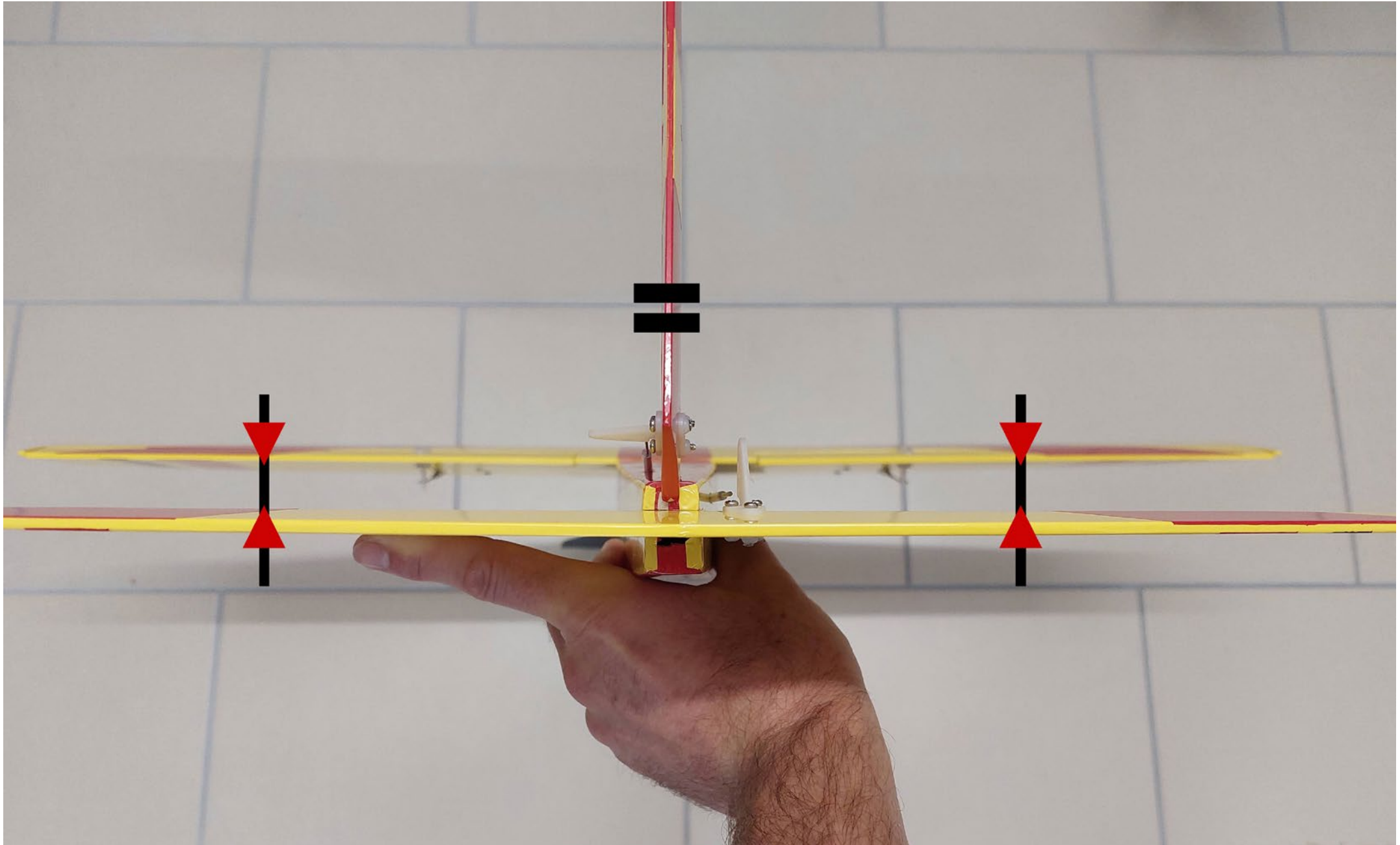





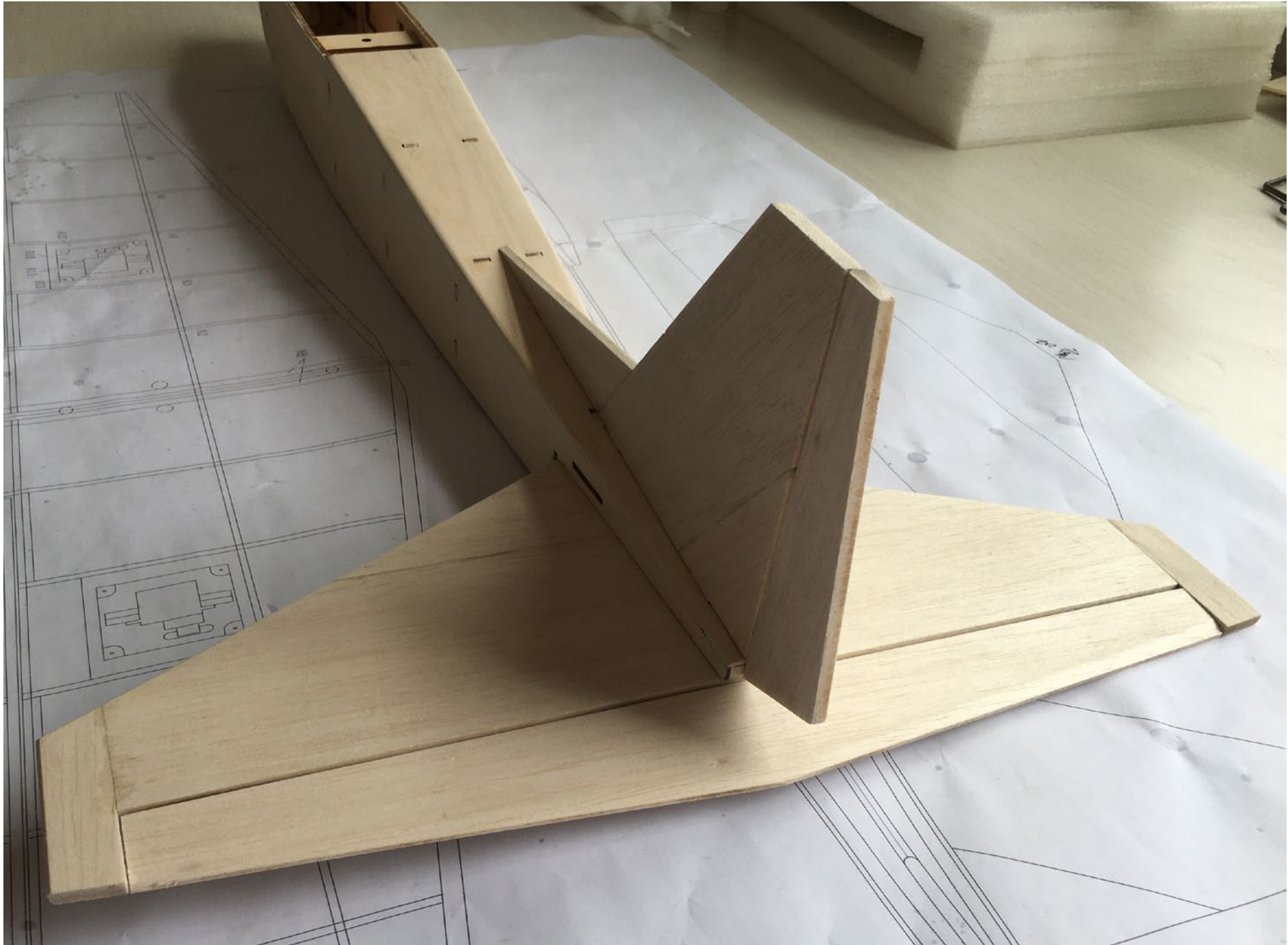
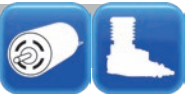

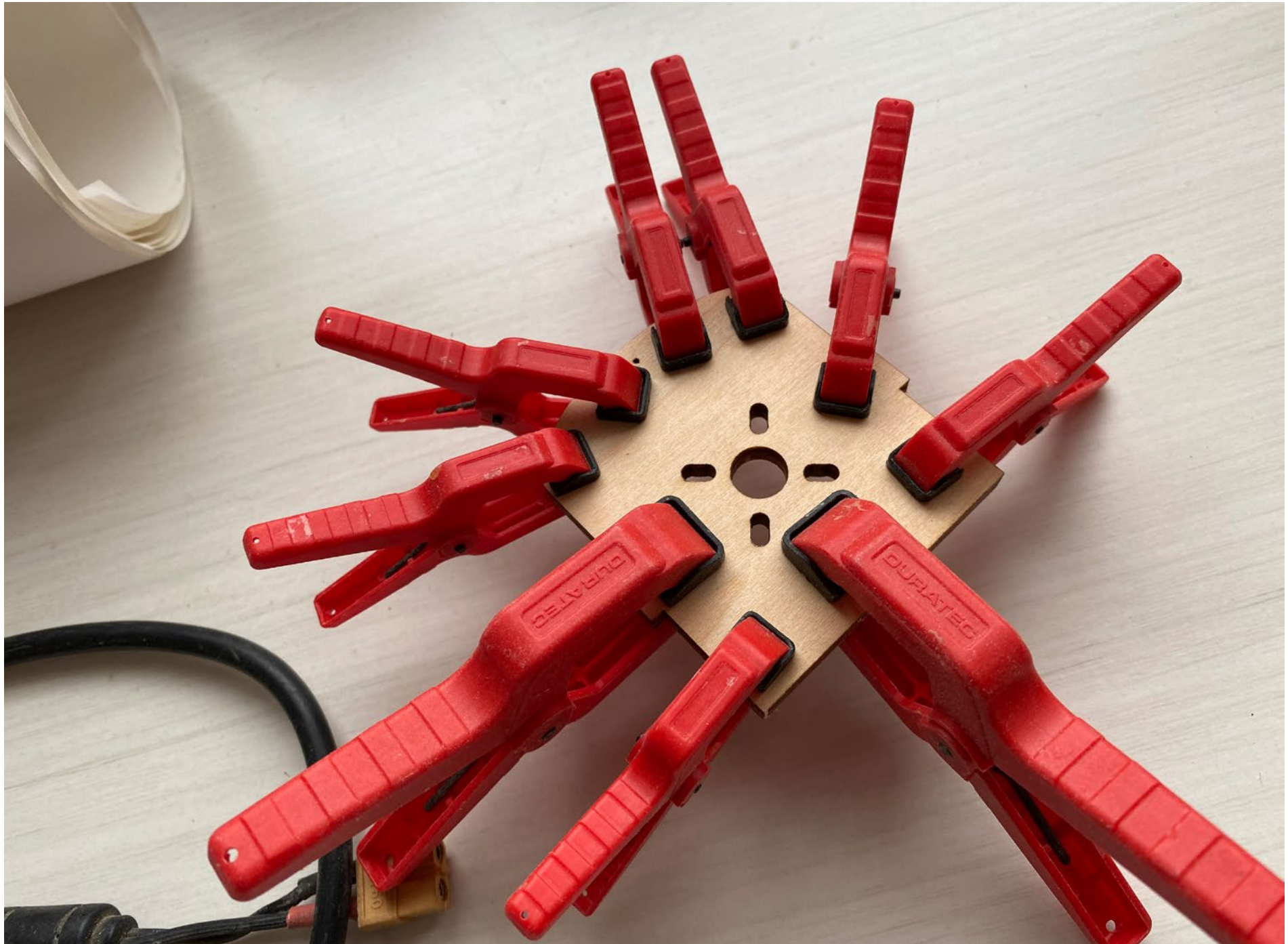

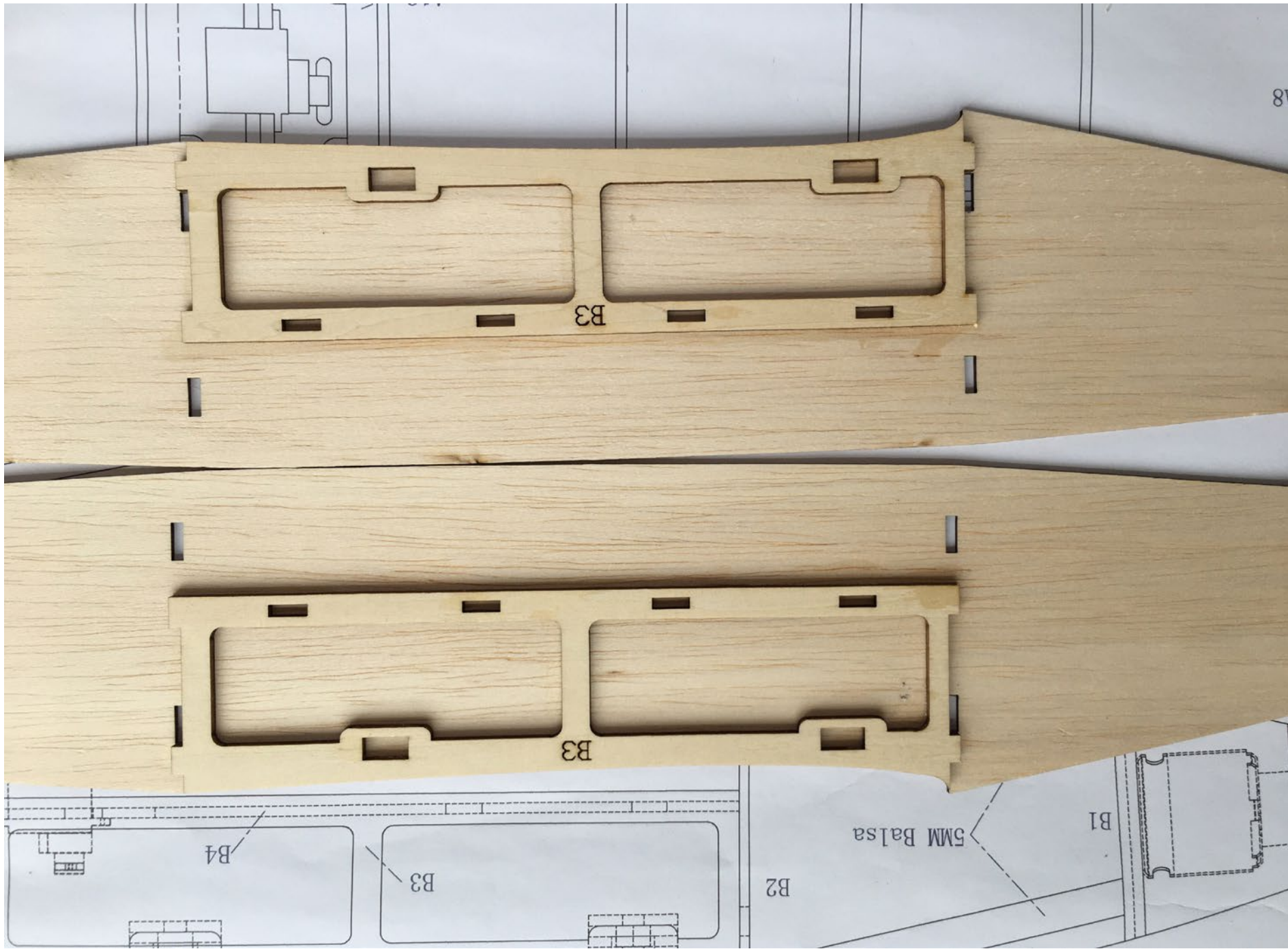

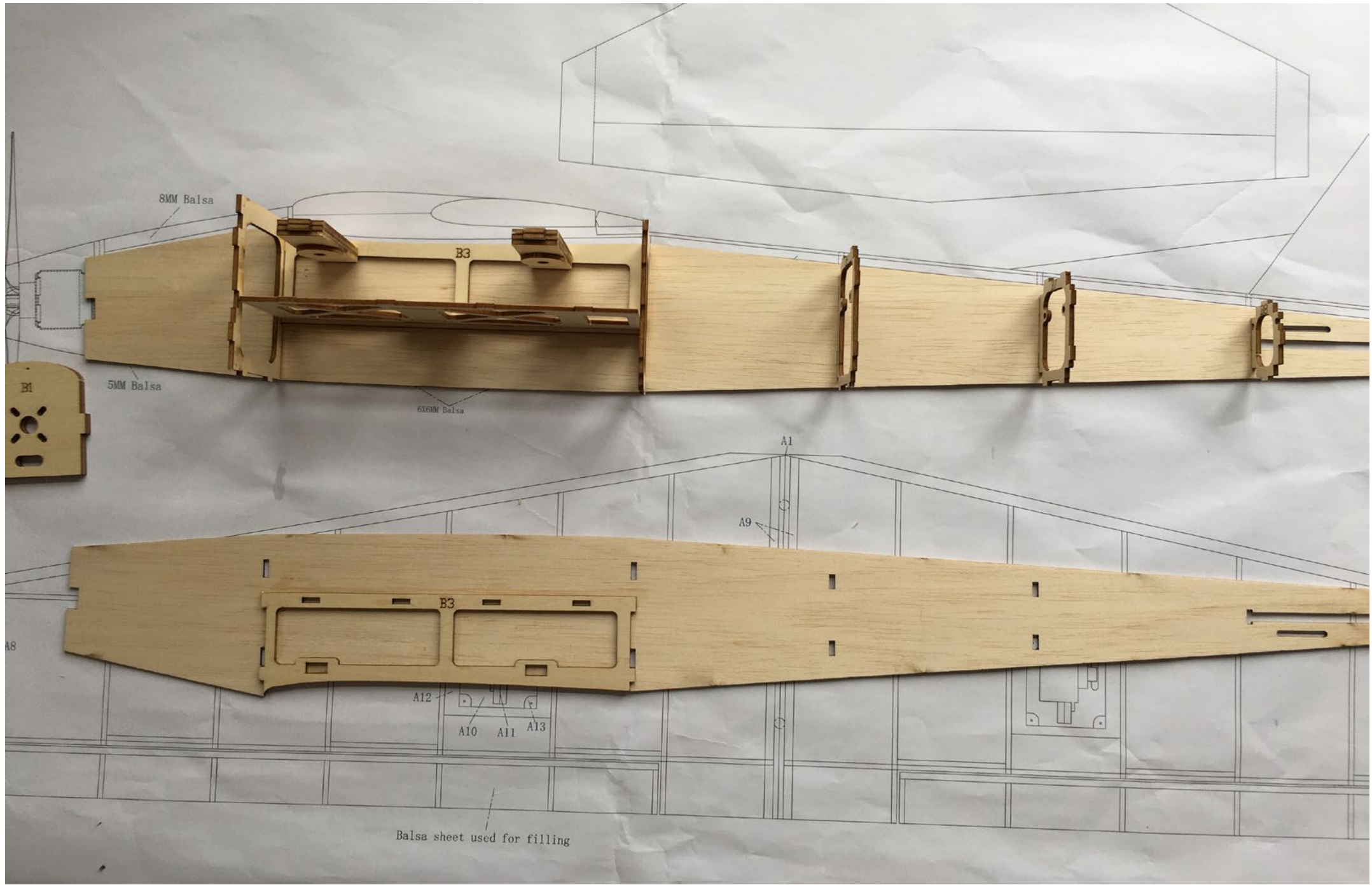

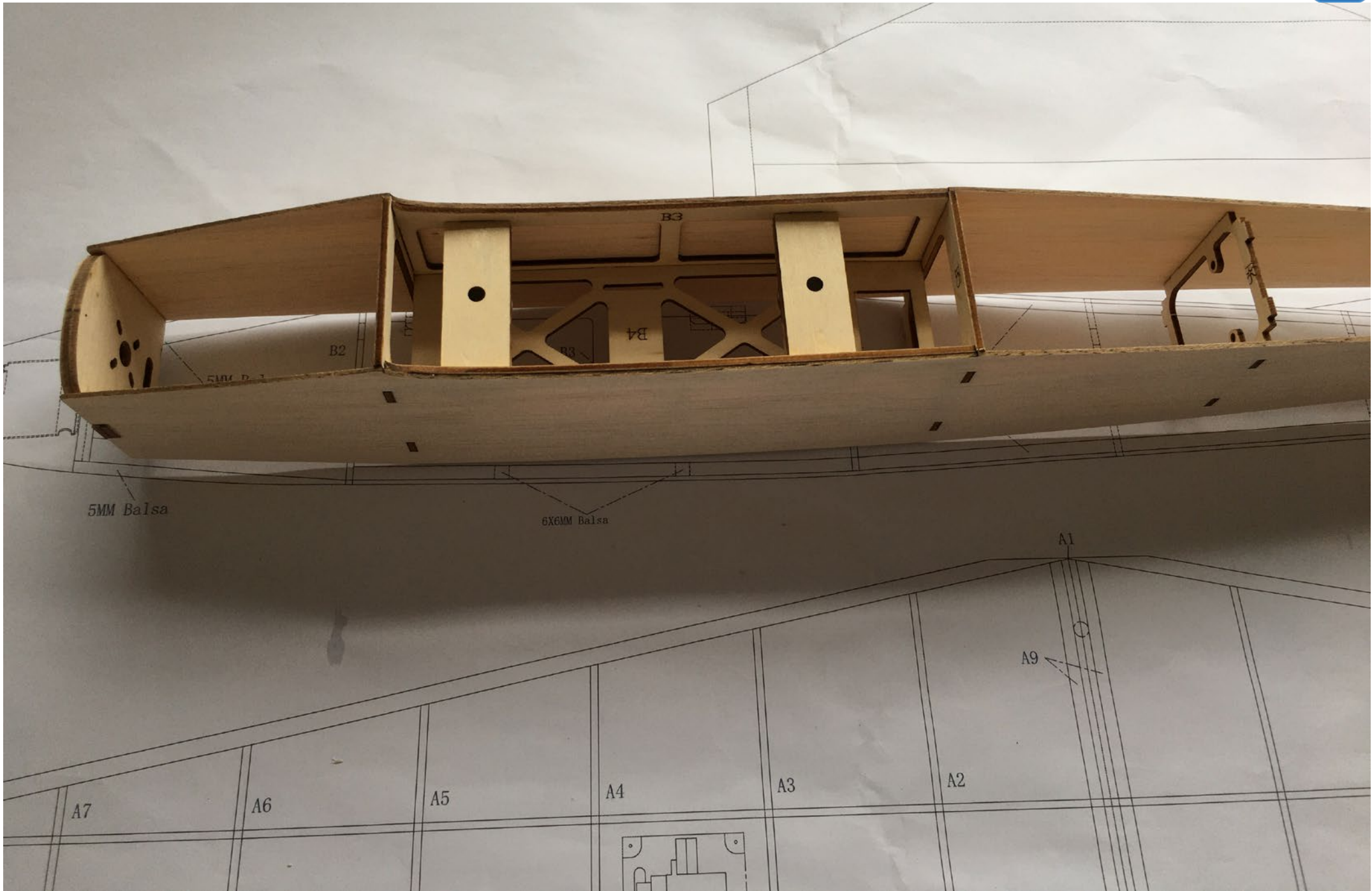

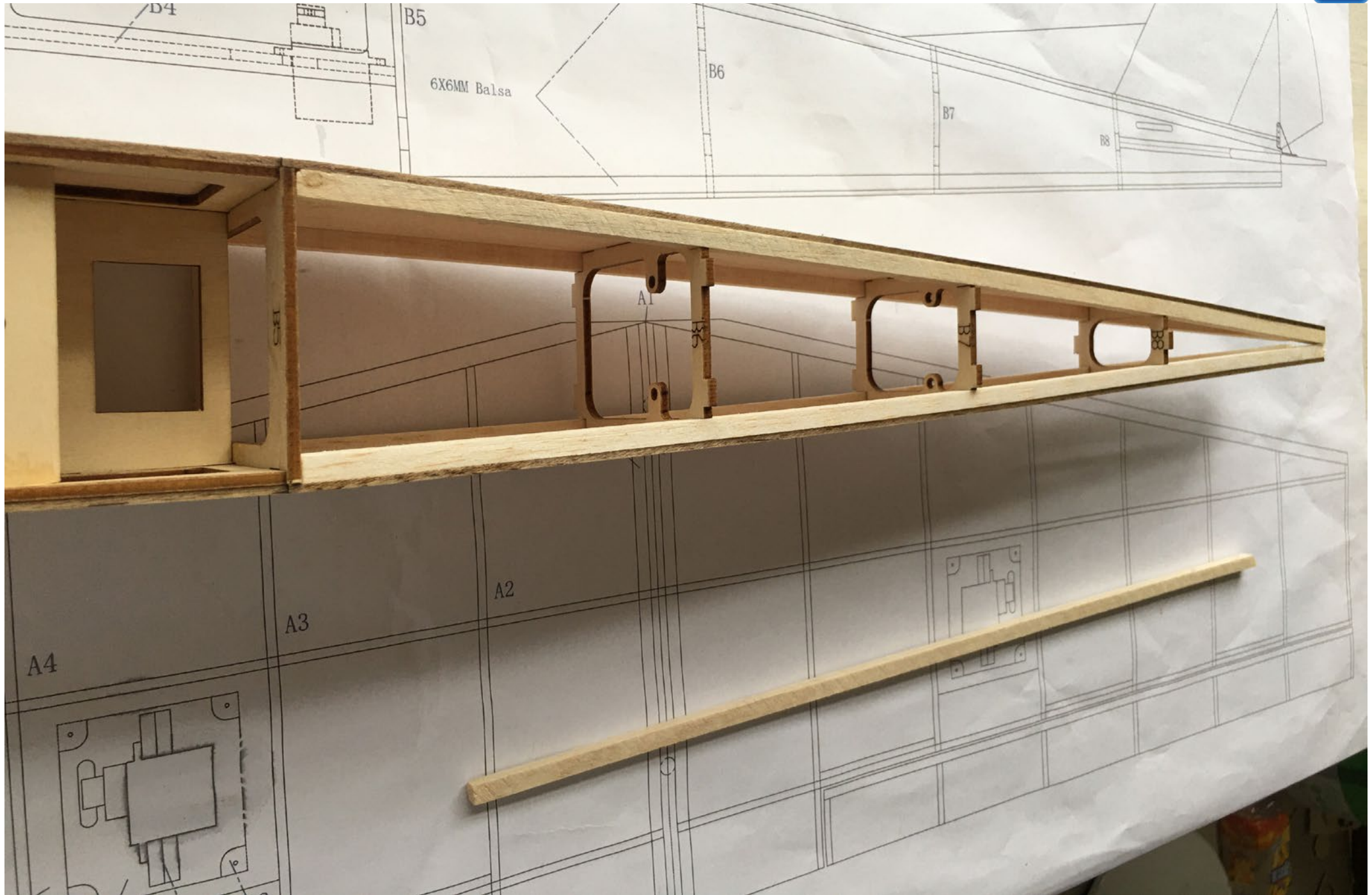





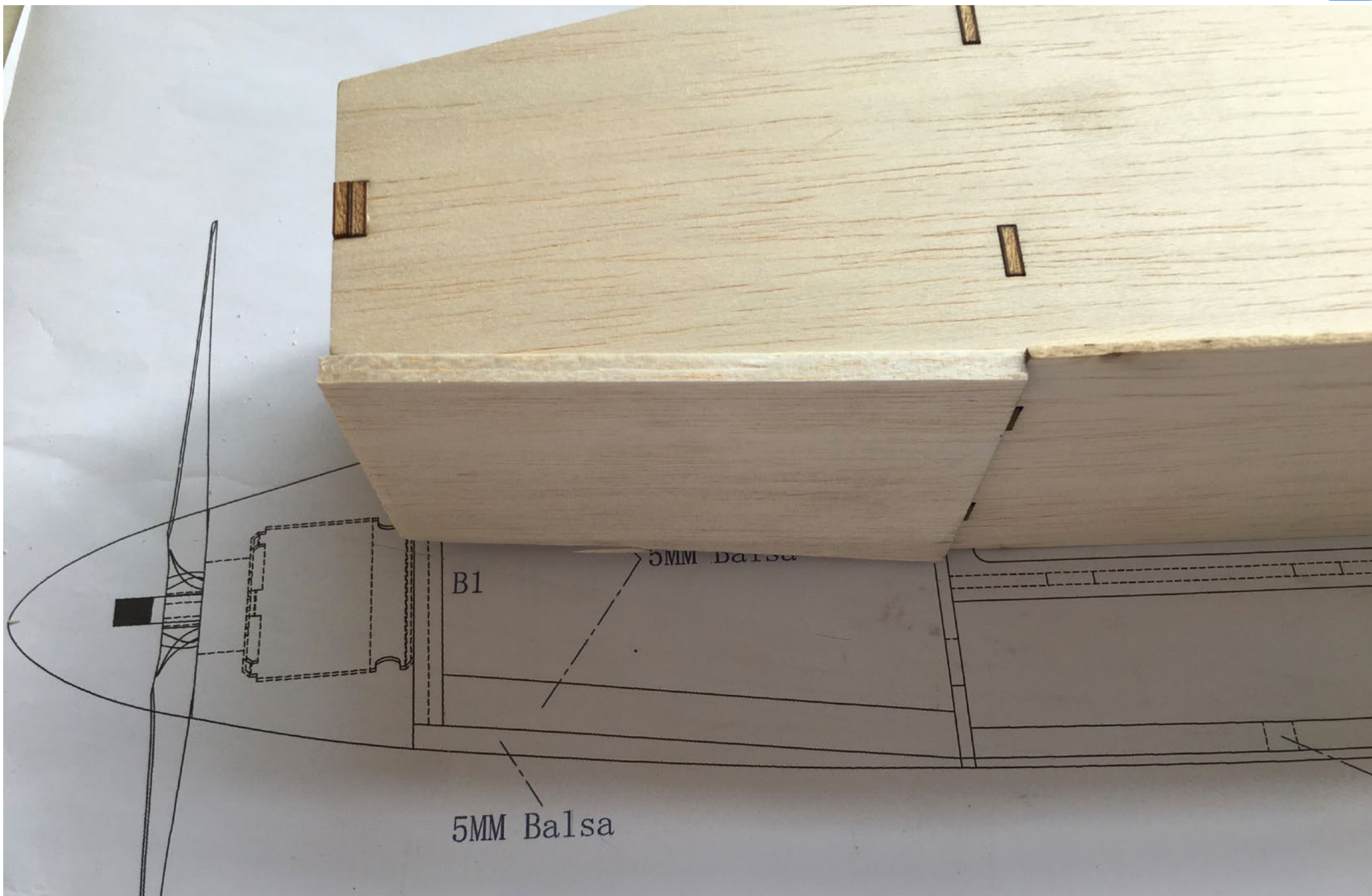

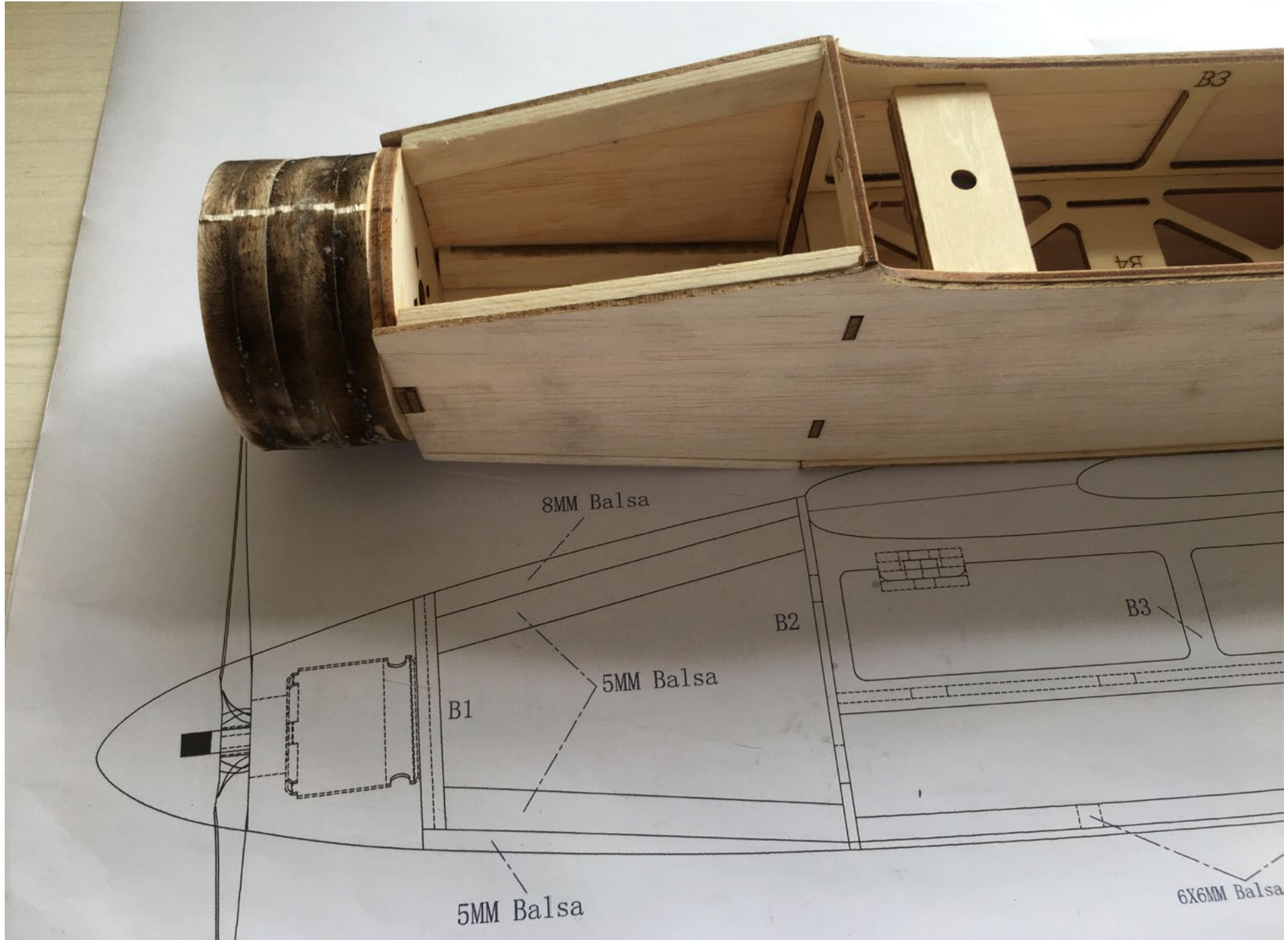



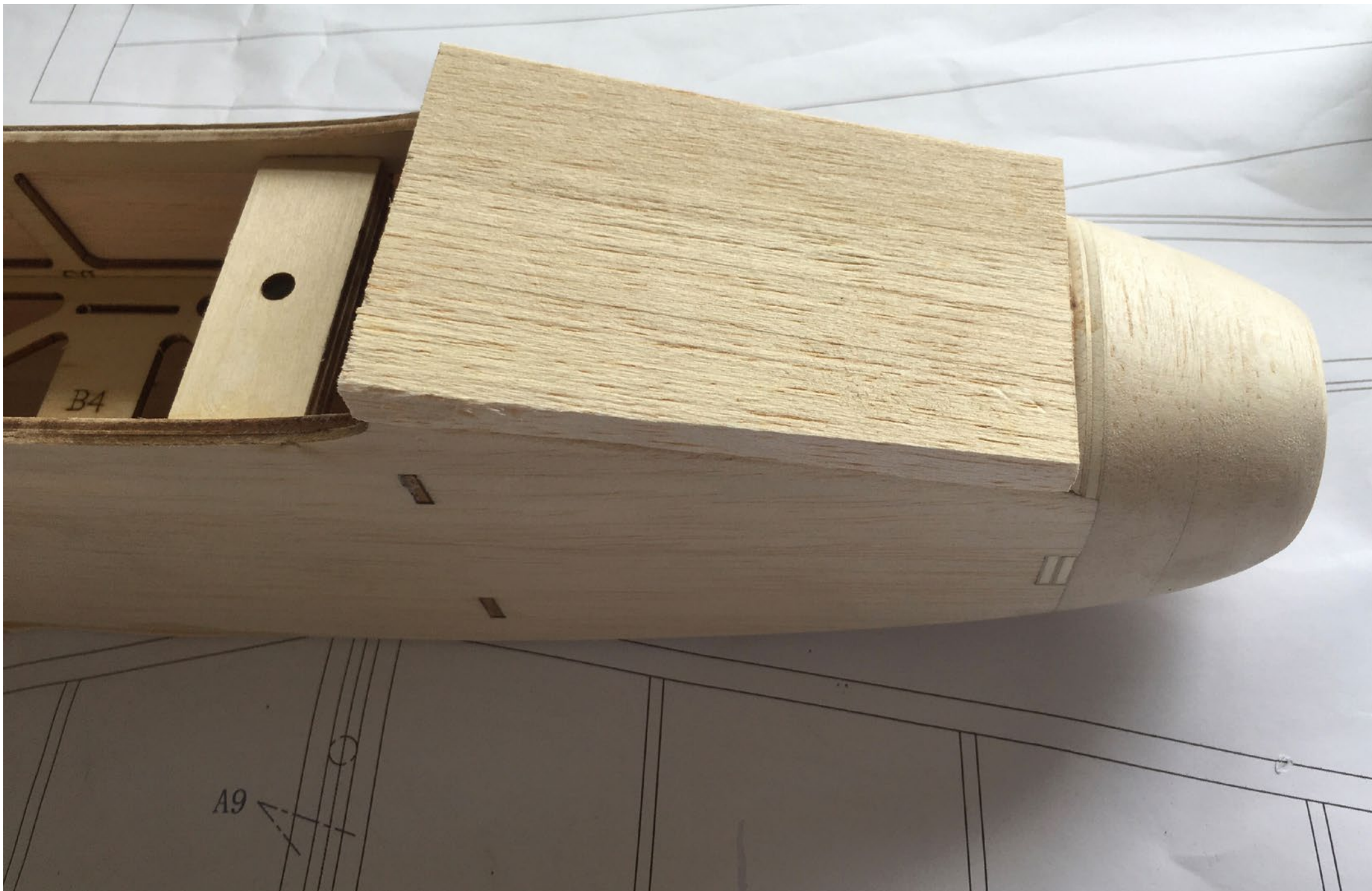







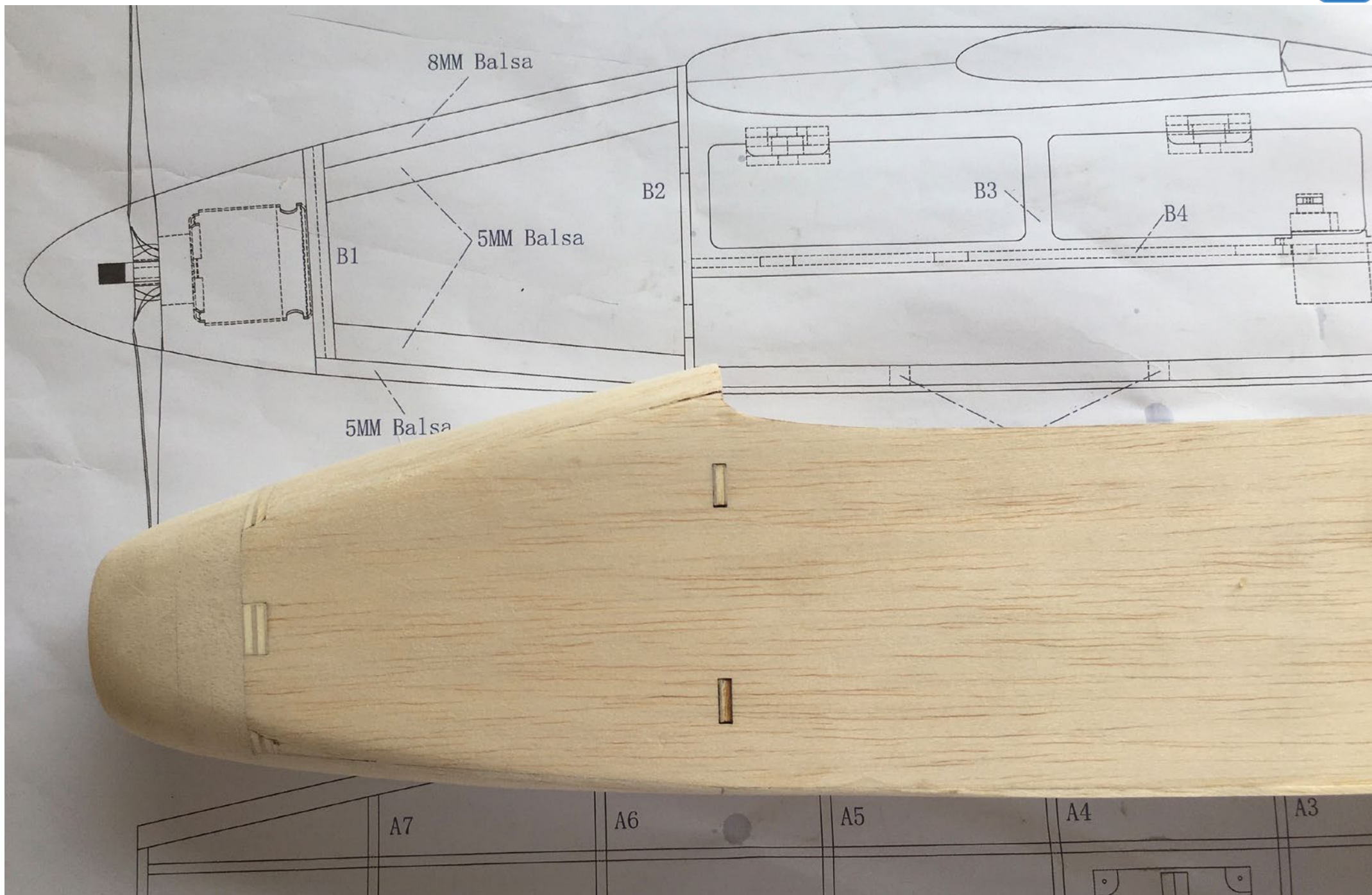



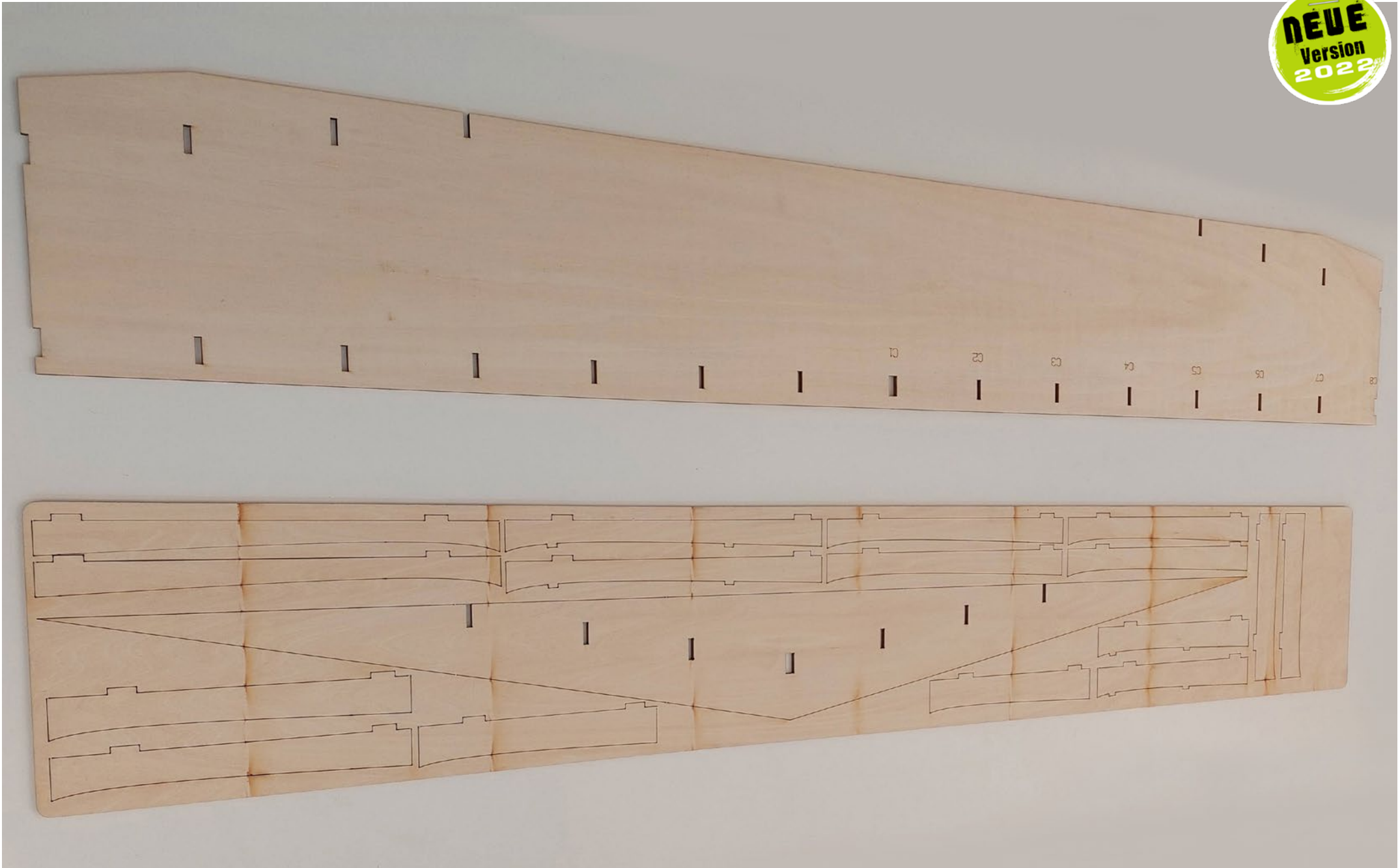

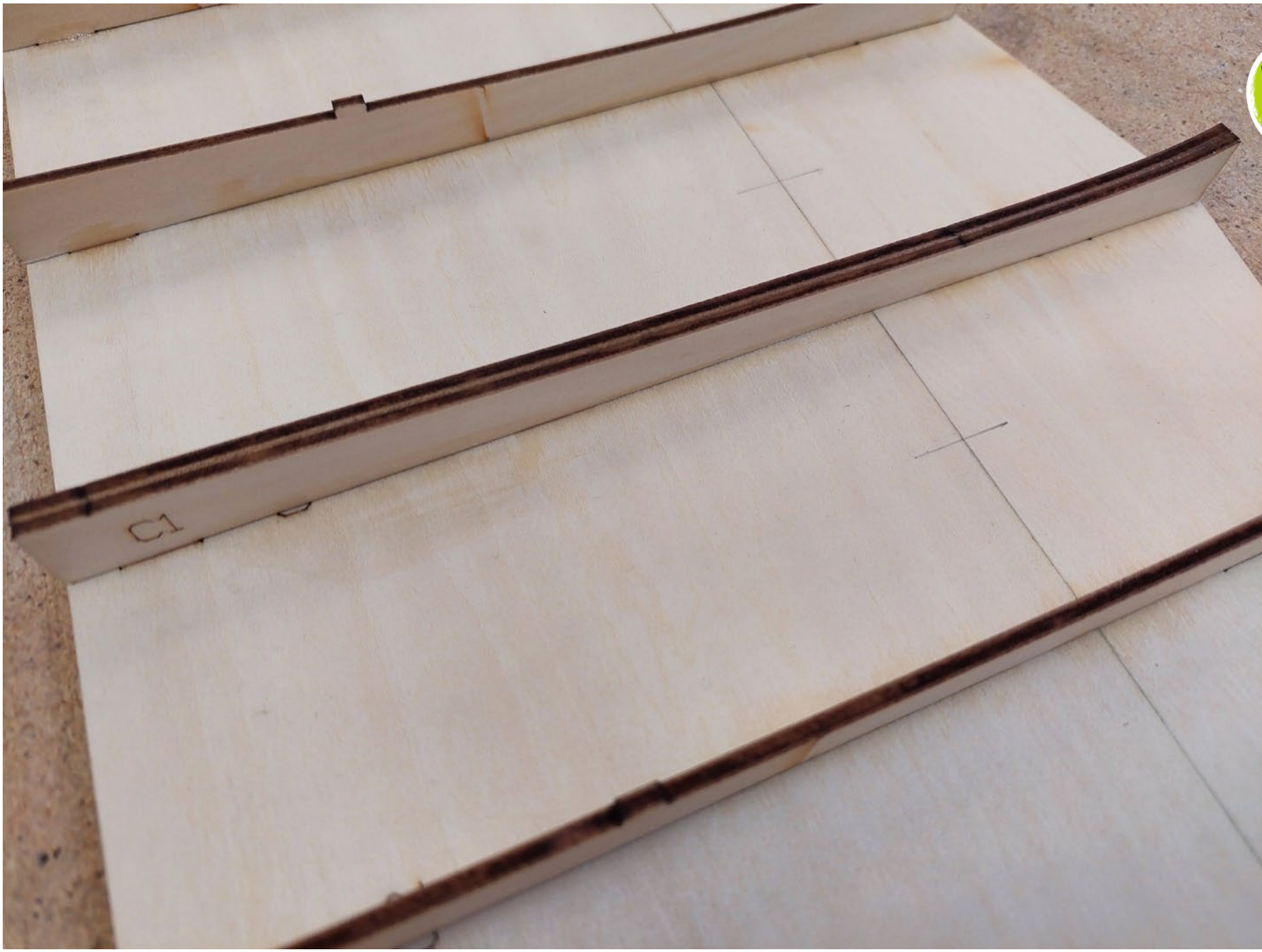













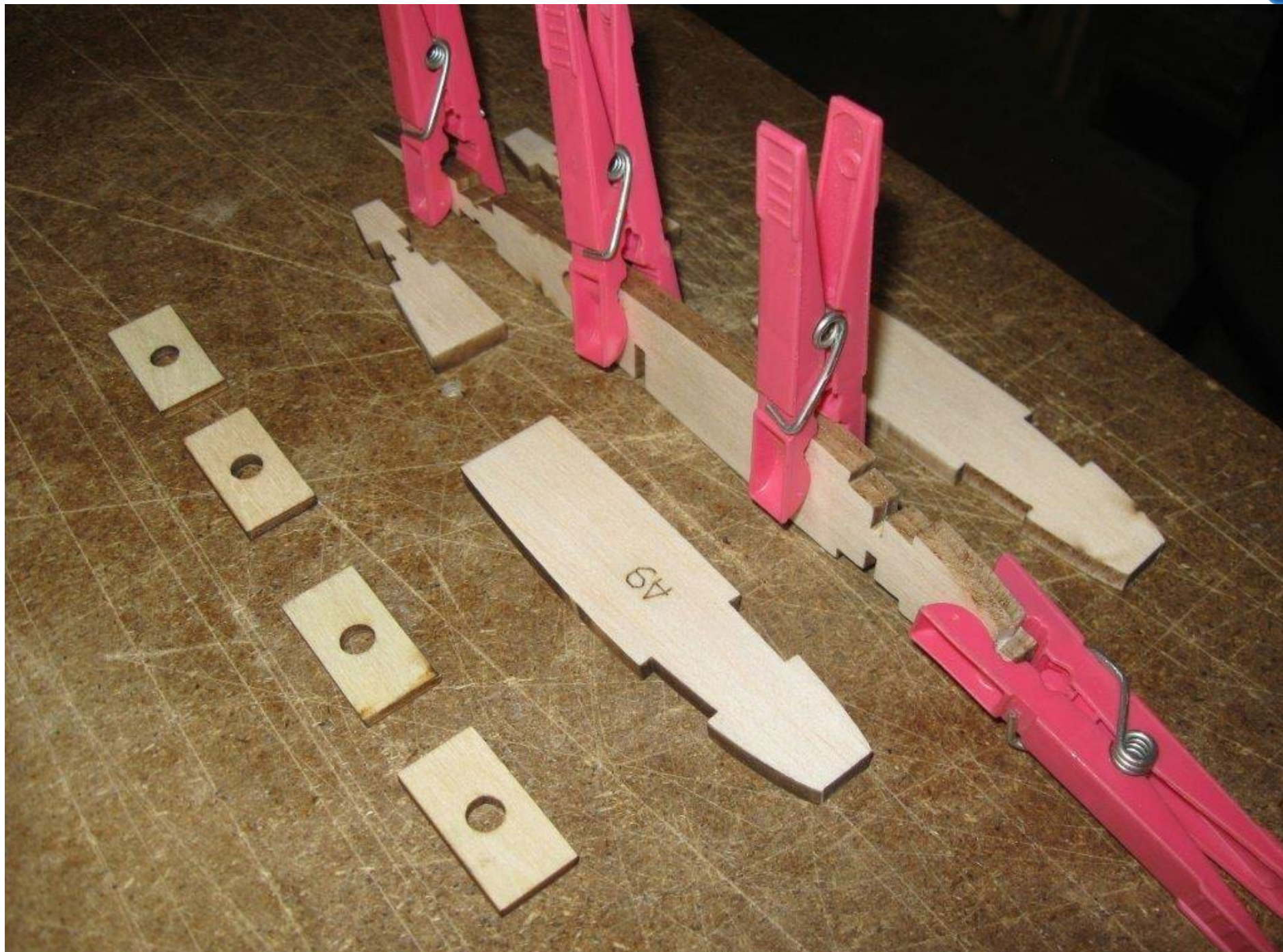

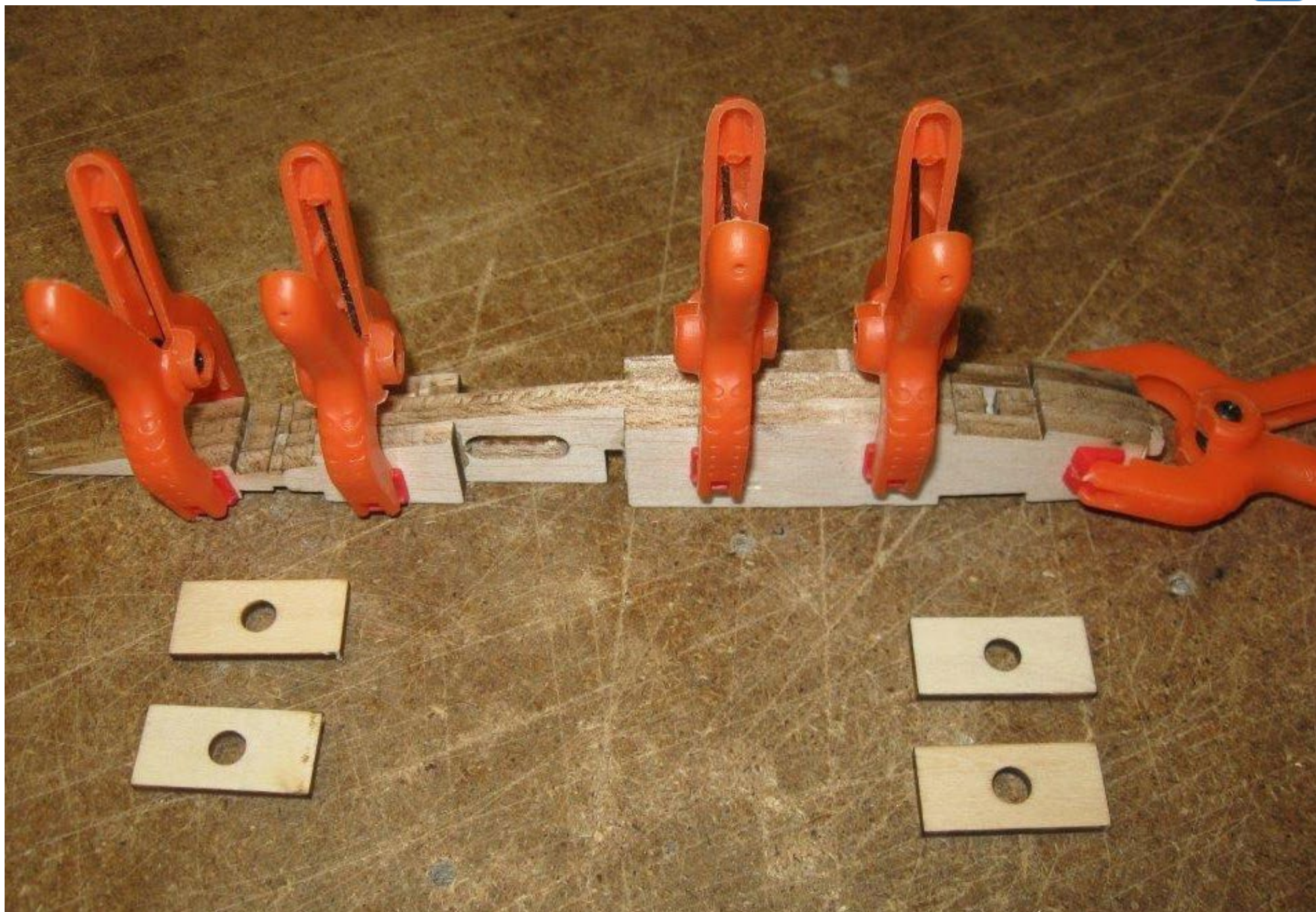

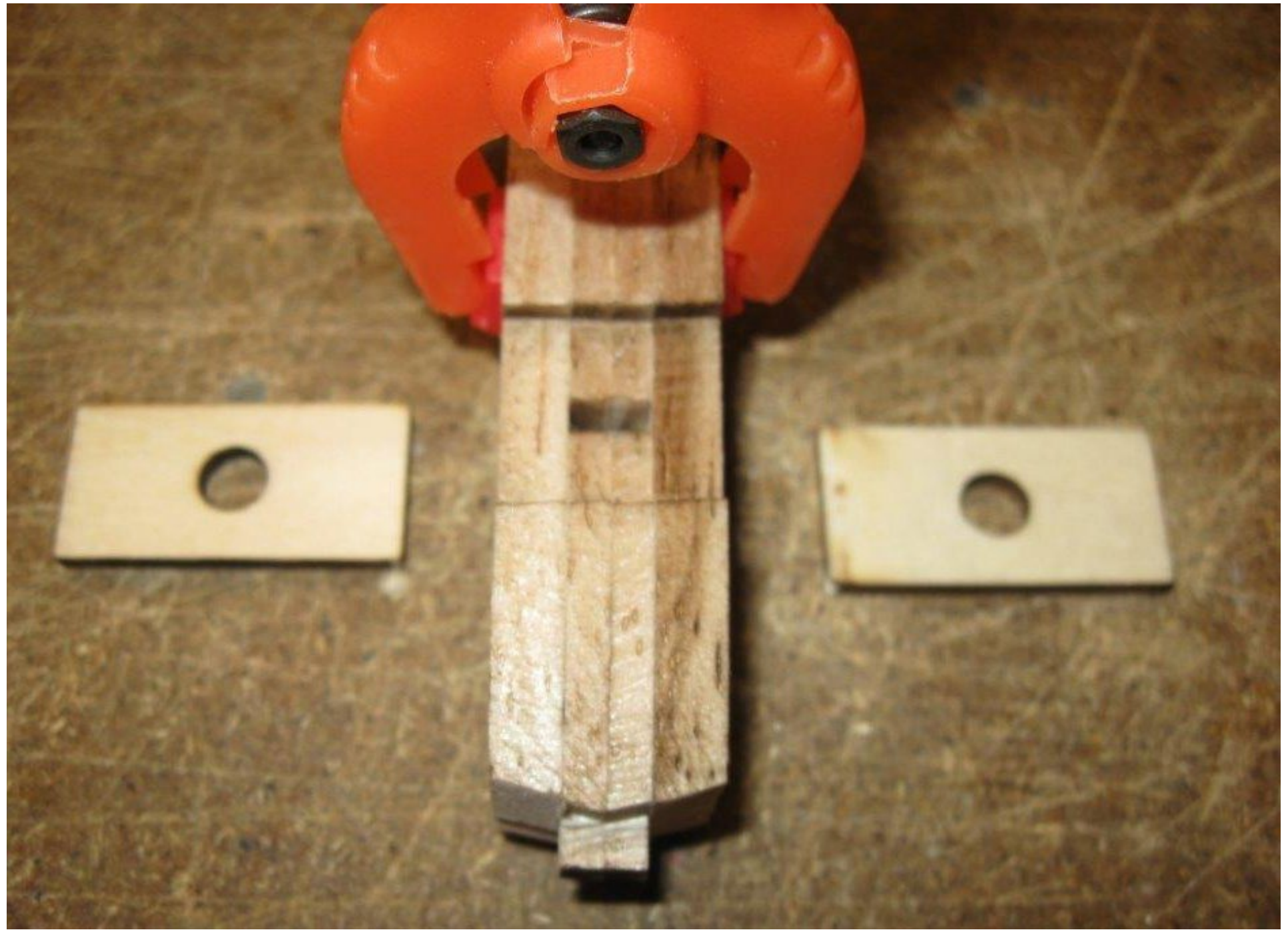

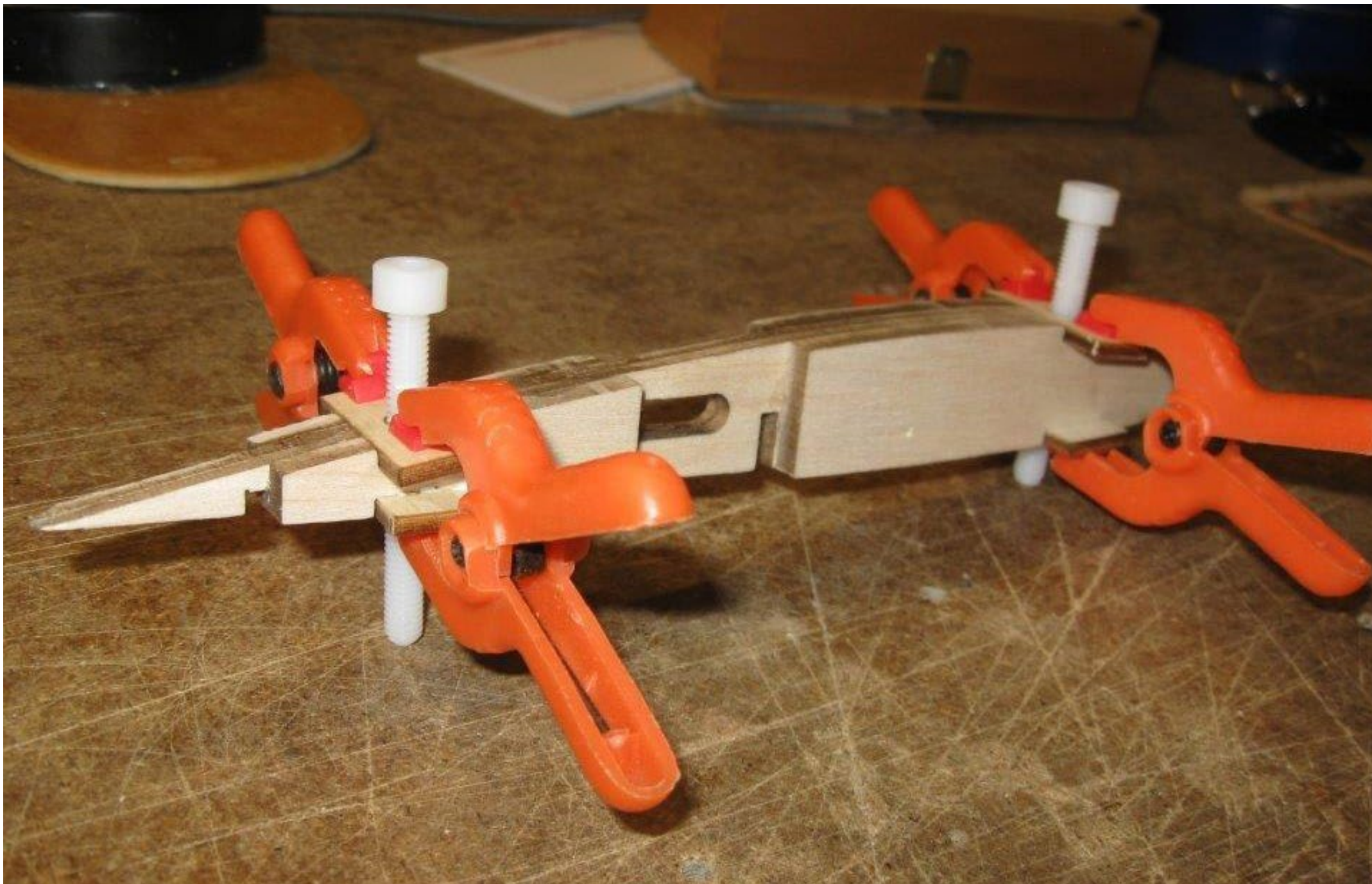

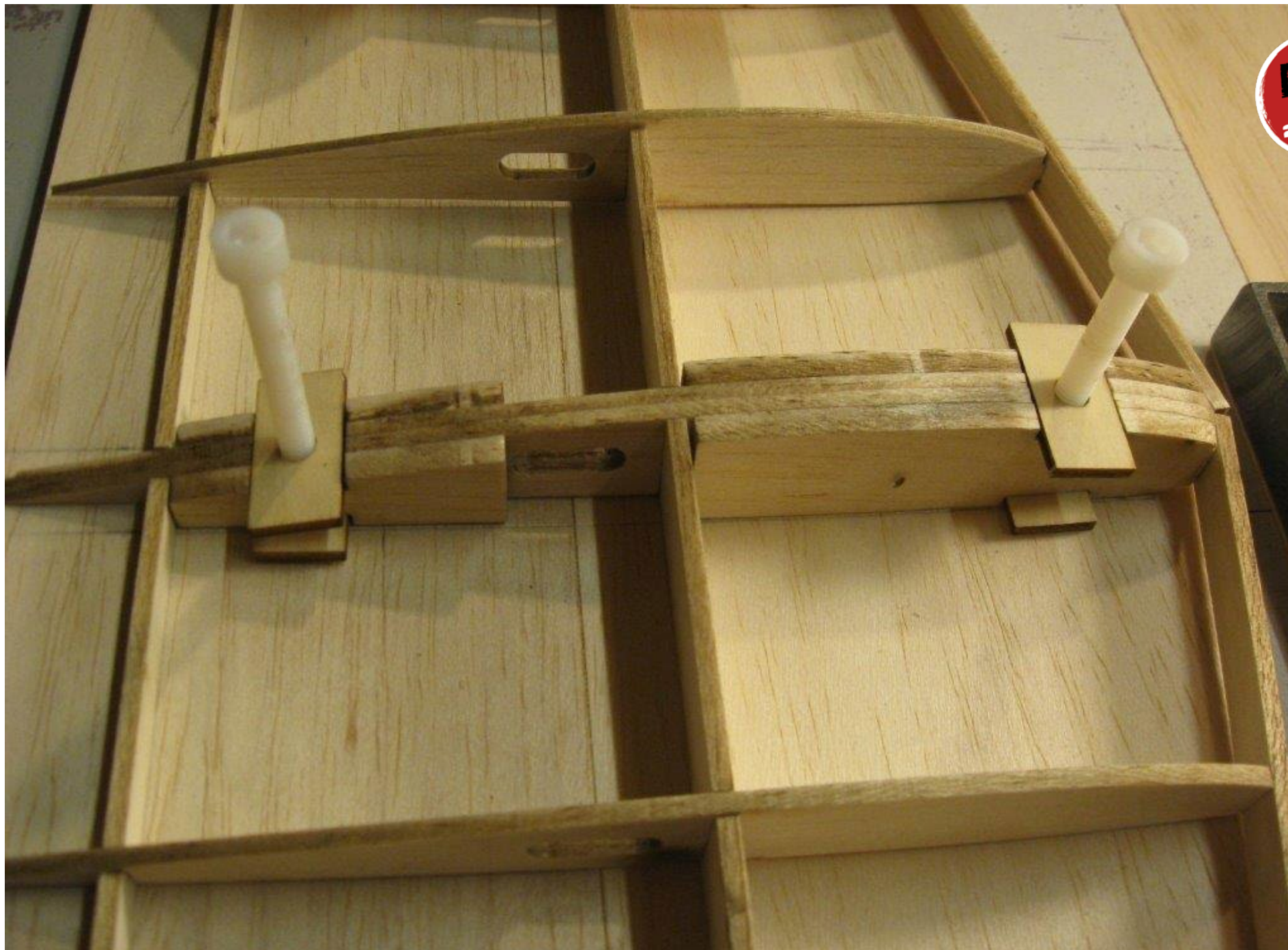













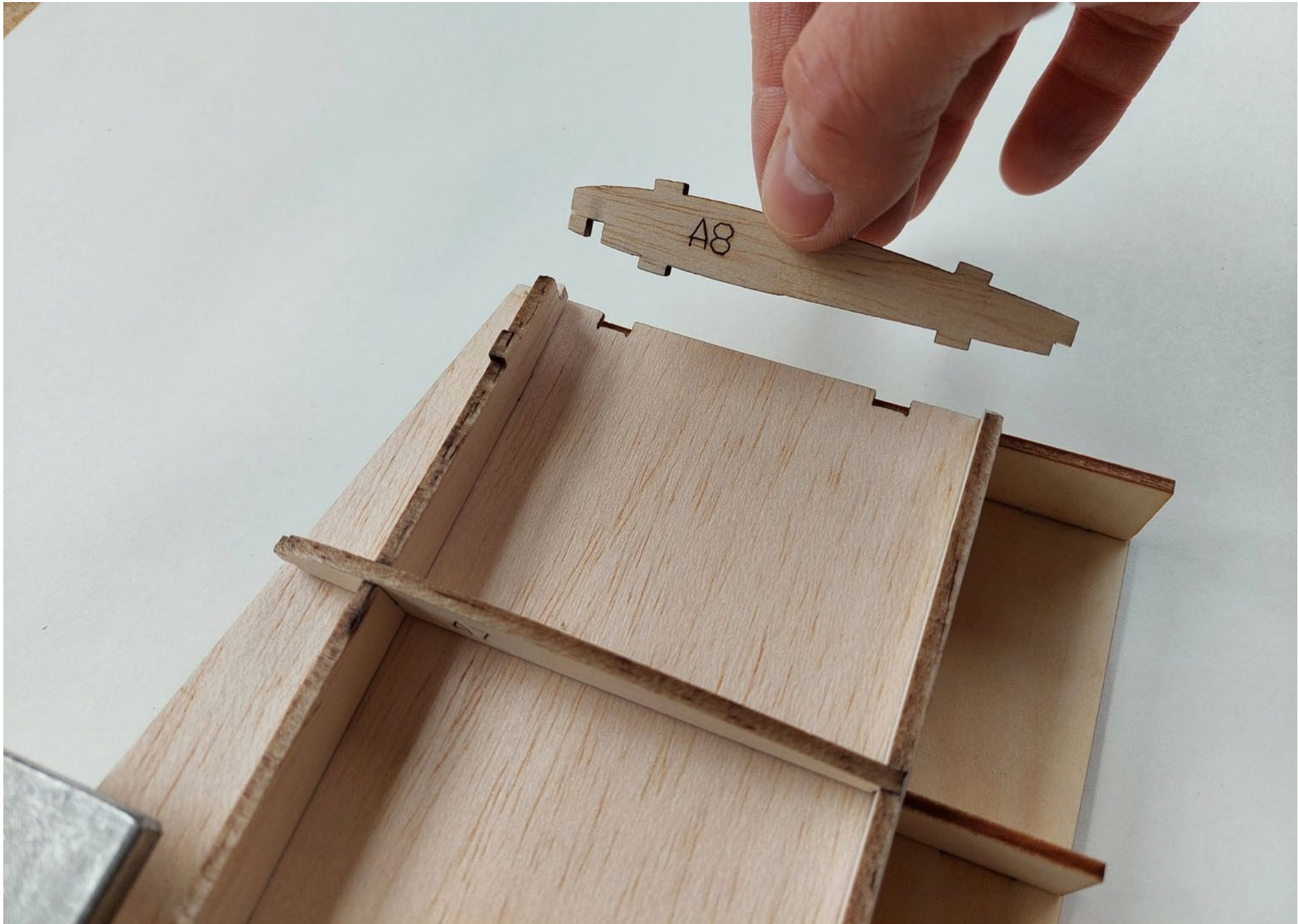



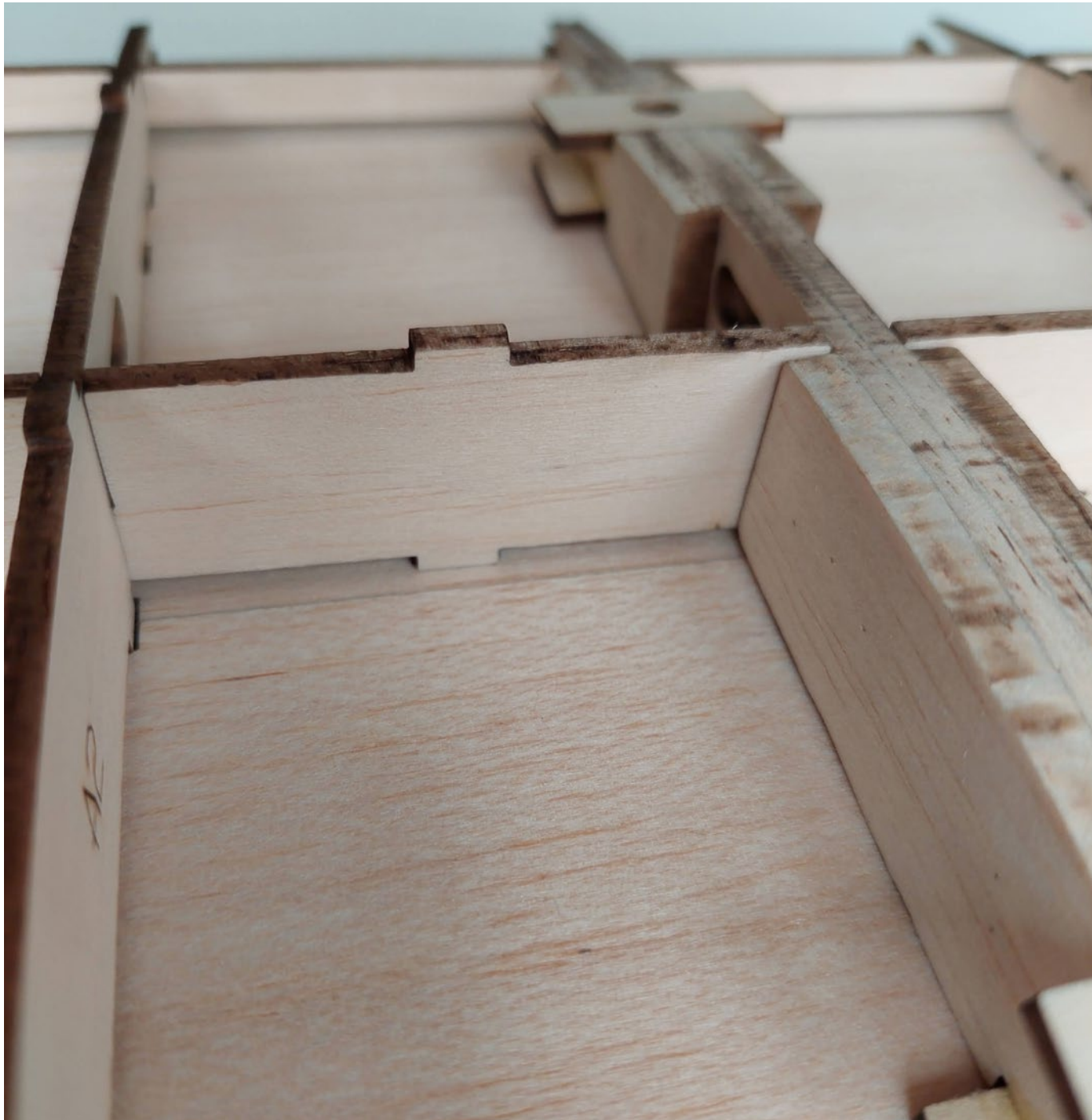





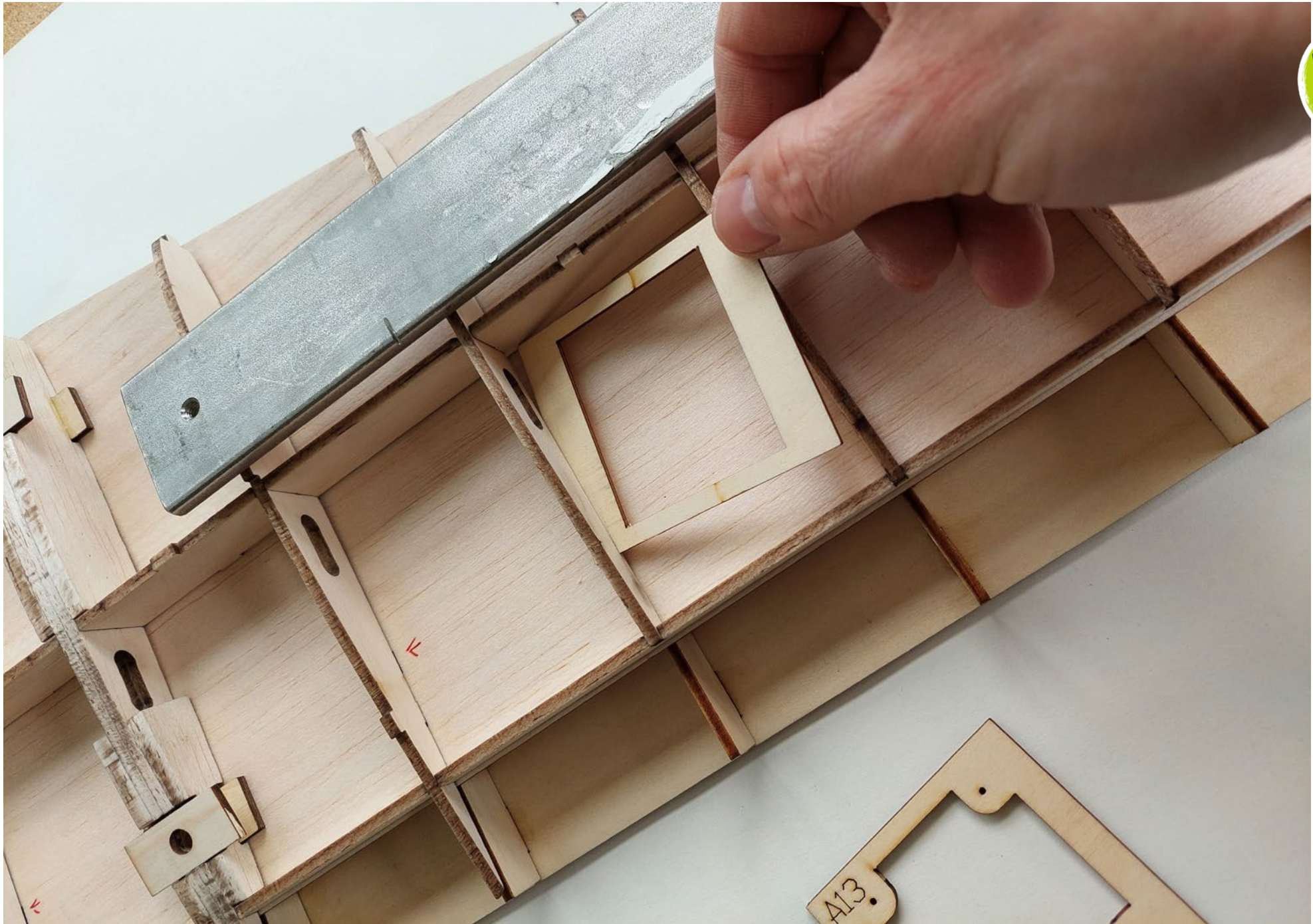









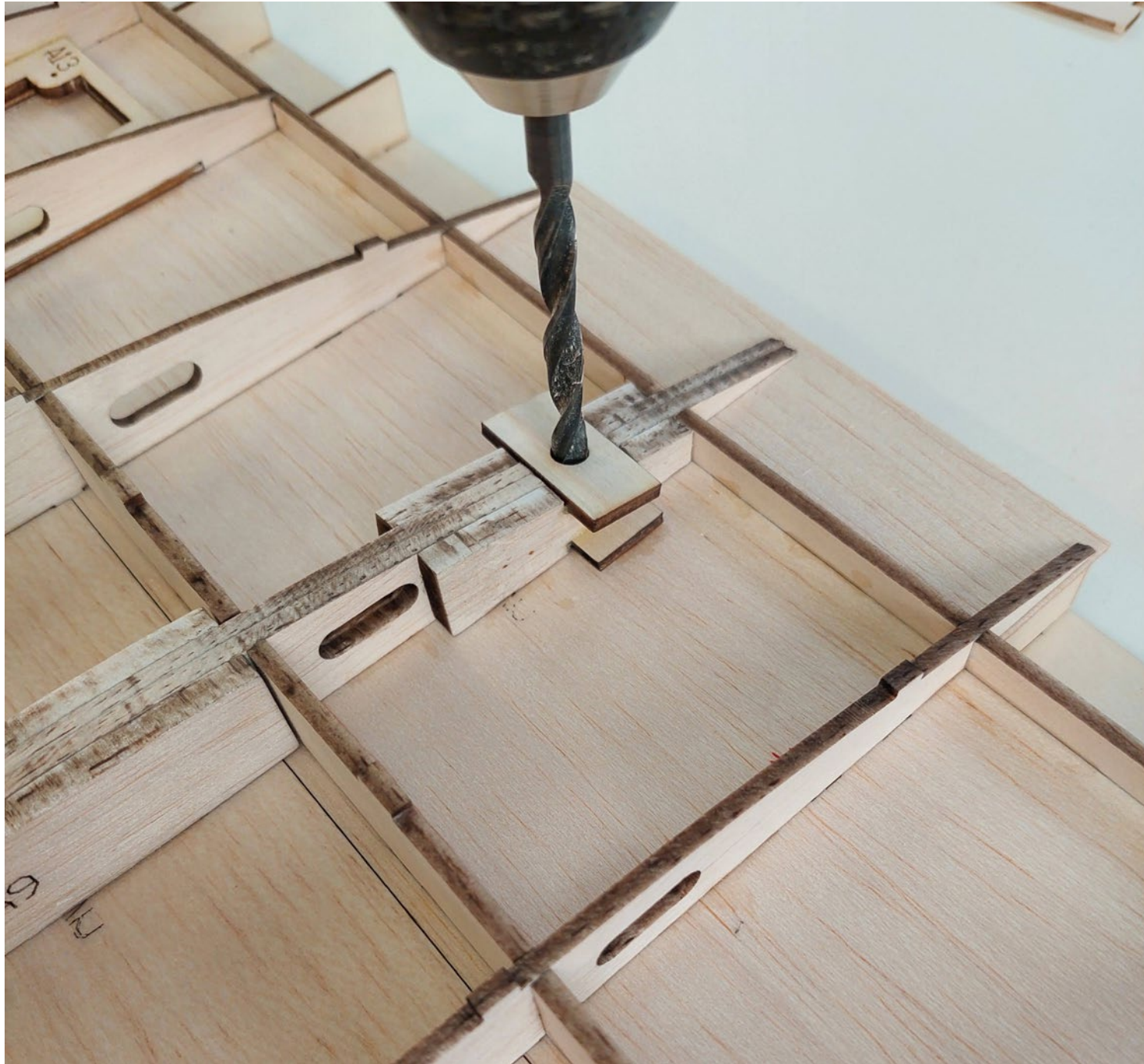





used for filling

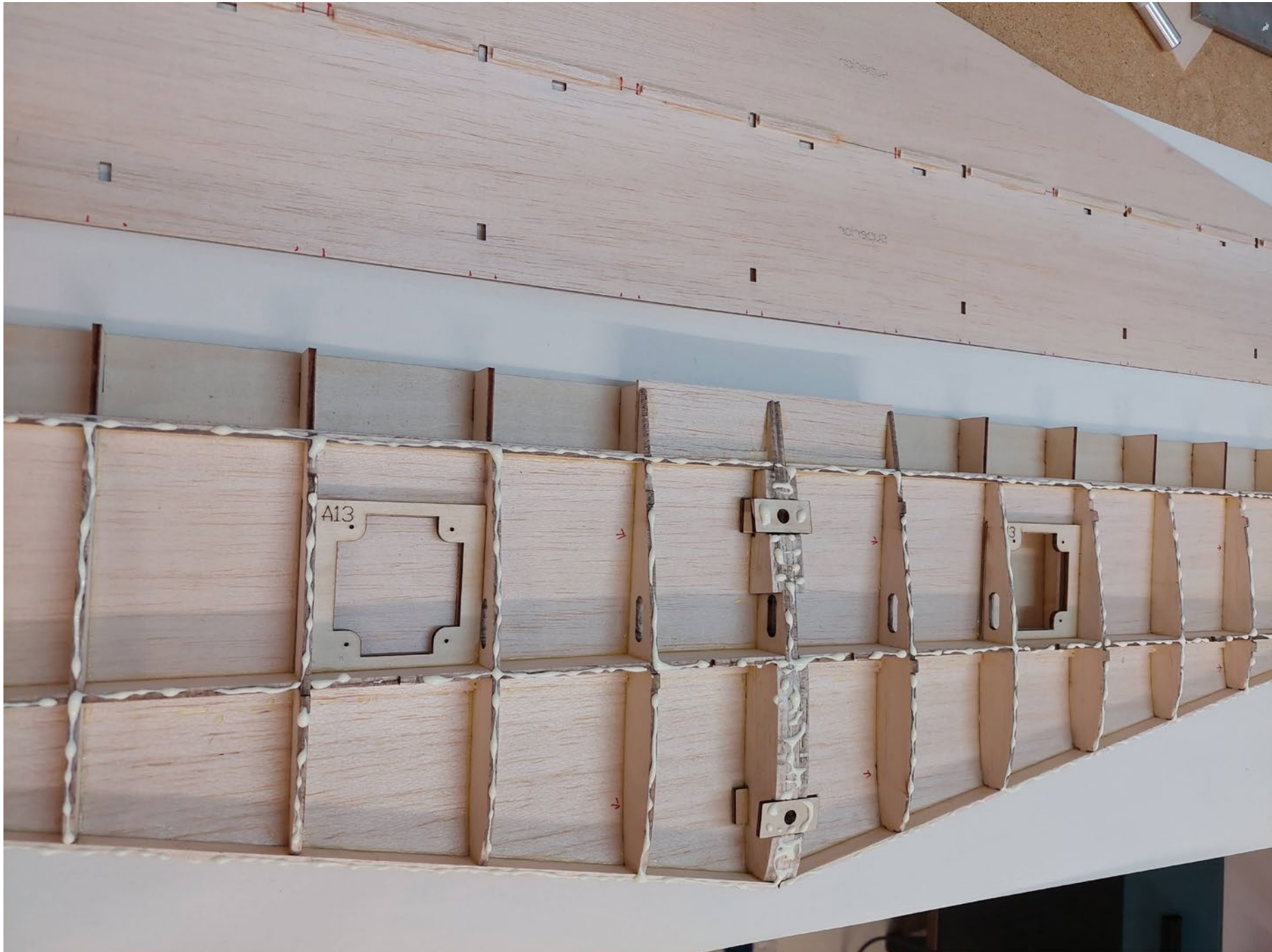



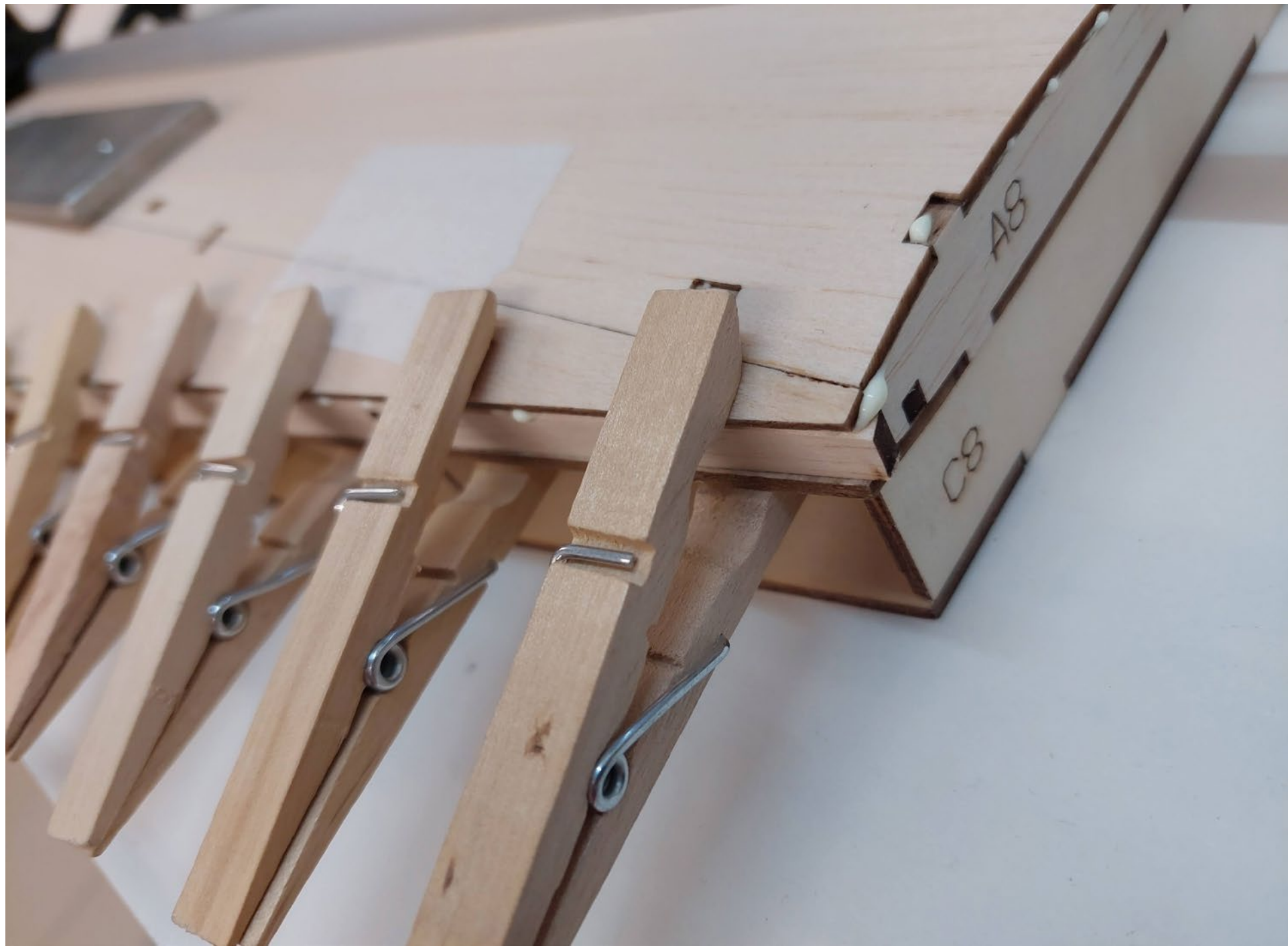

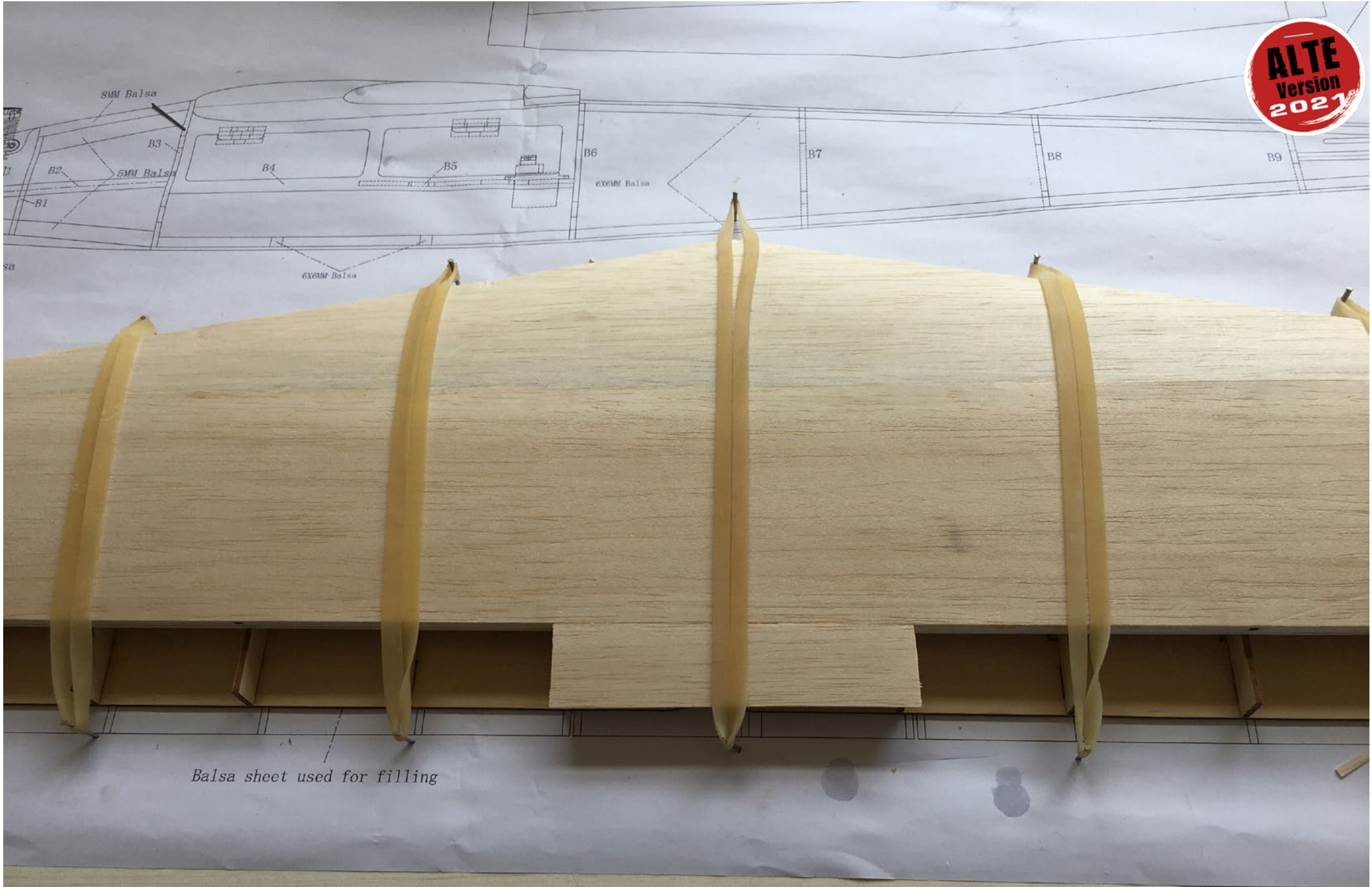

Balsa sheet used for filling

35aa

D. TRAGFLÄCHE BEIDE ANTRIEBSVERSIONEN / WING CONSTRUCTION BOTH VERSIONS / LES AILES POUR LES DEUX VERSIONS

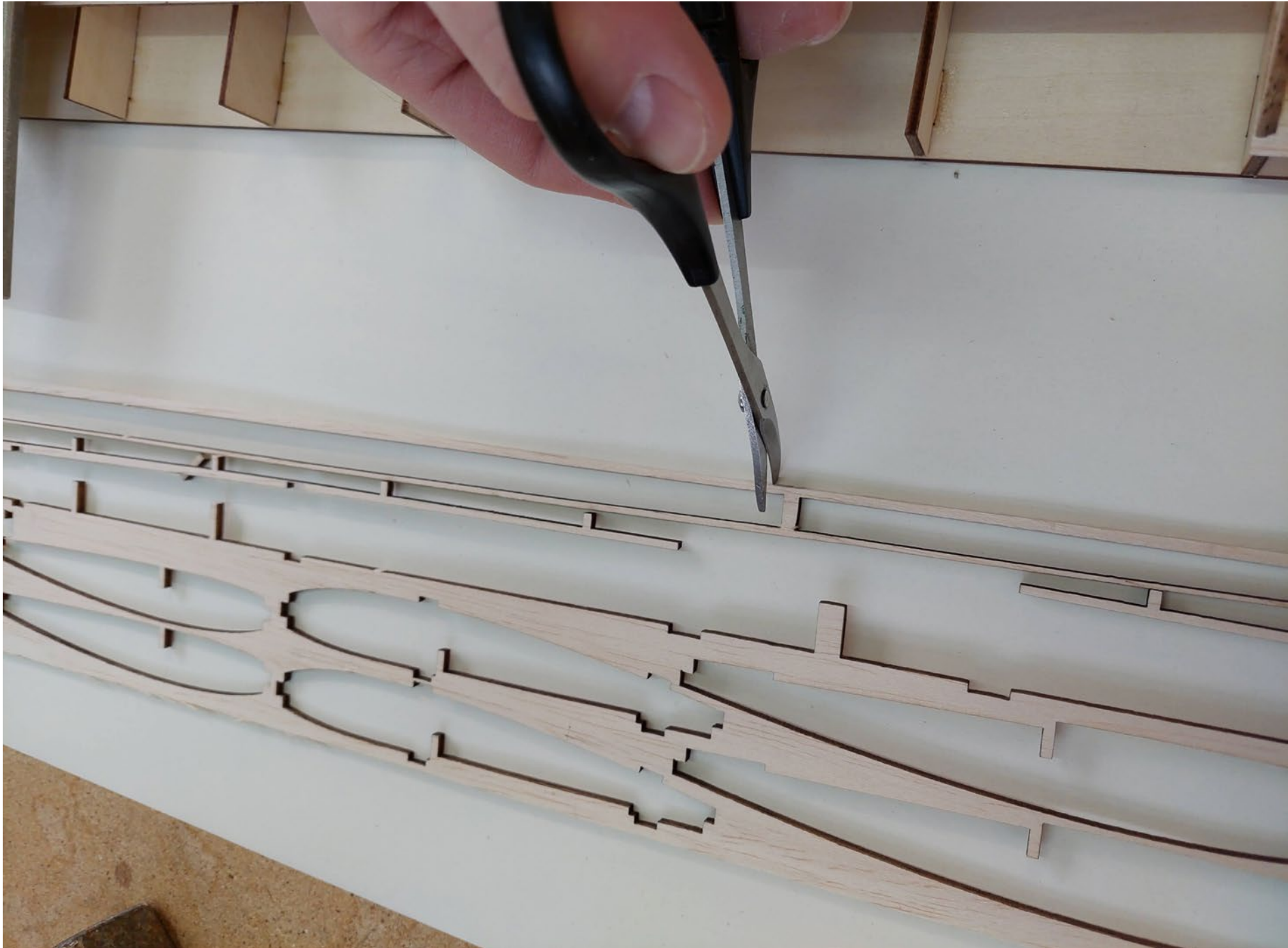



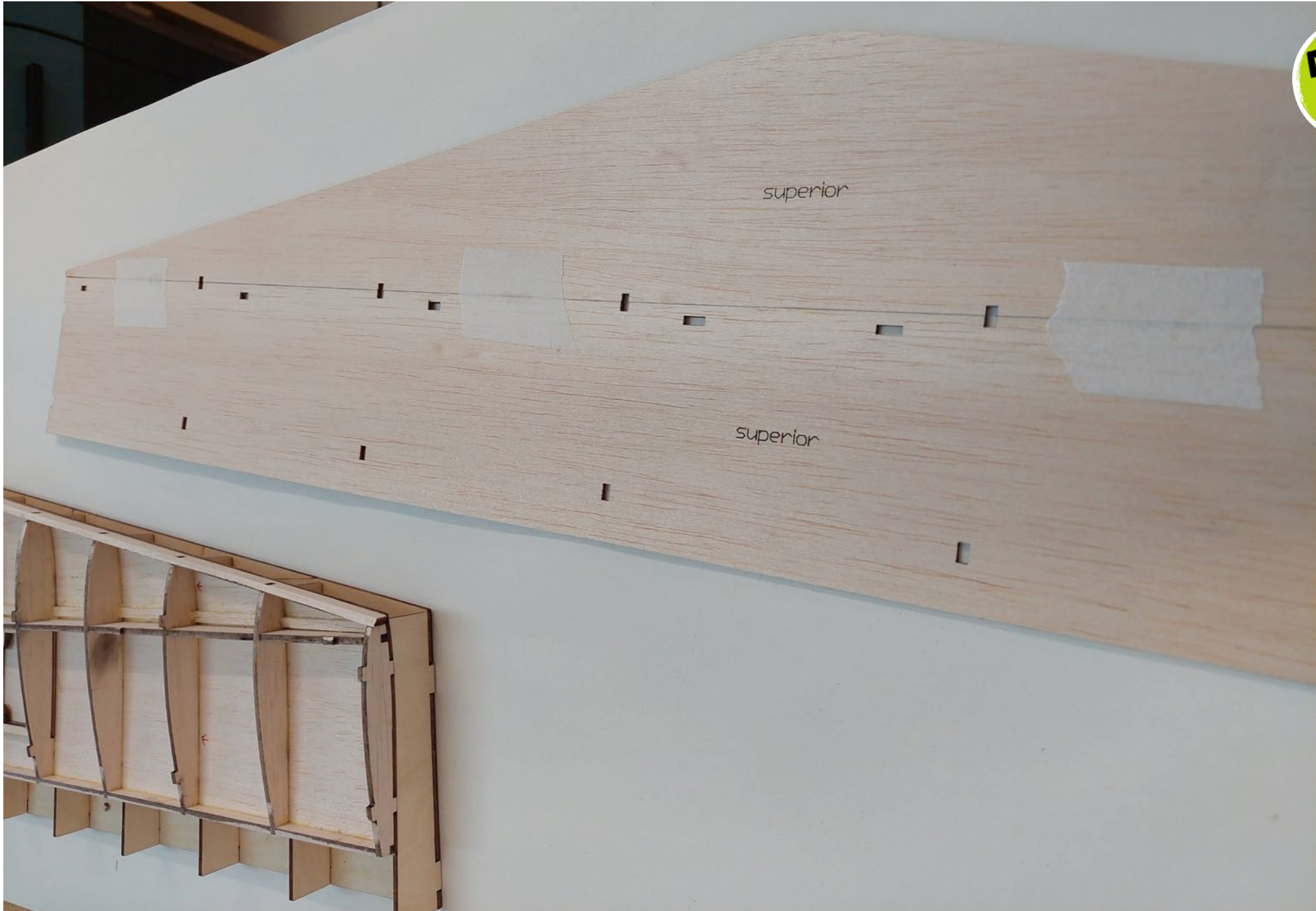

35ad

D. TRAGFLÄCHE BEIDE ANTRIEBSVERSIONEN / WING CONSTRUCTION BOTH VERSIONS / LES AILES POUR LES DEUX VERSIONS



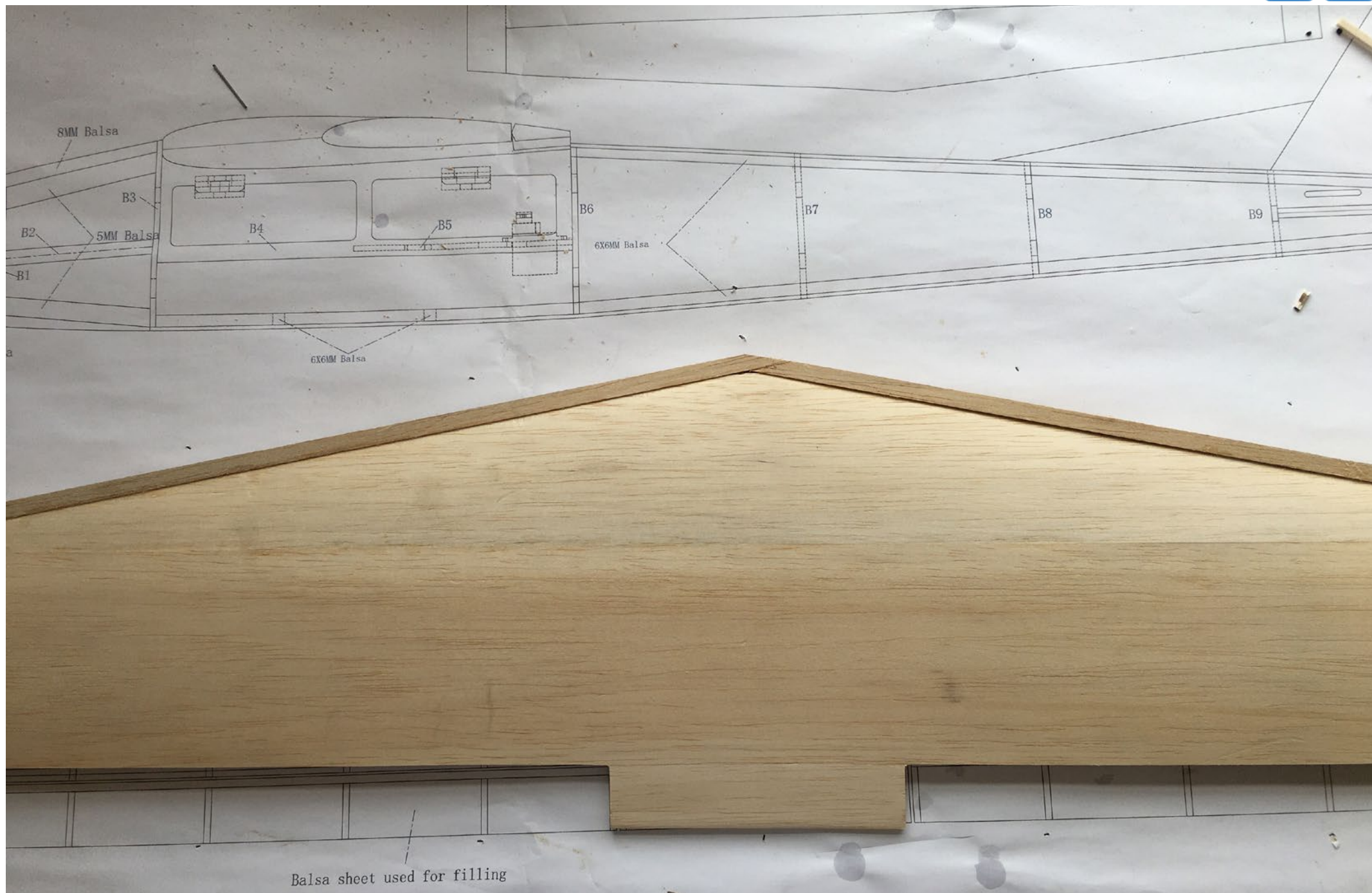



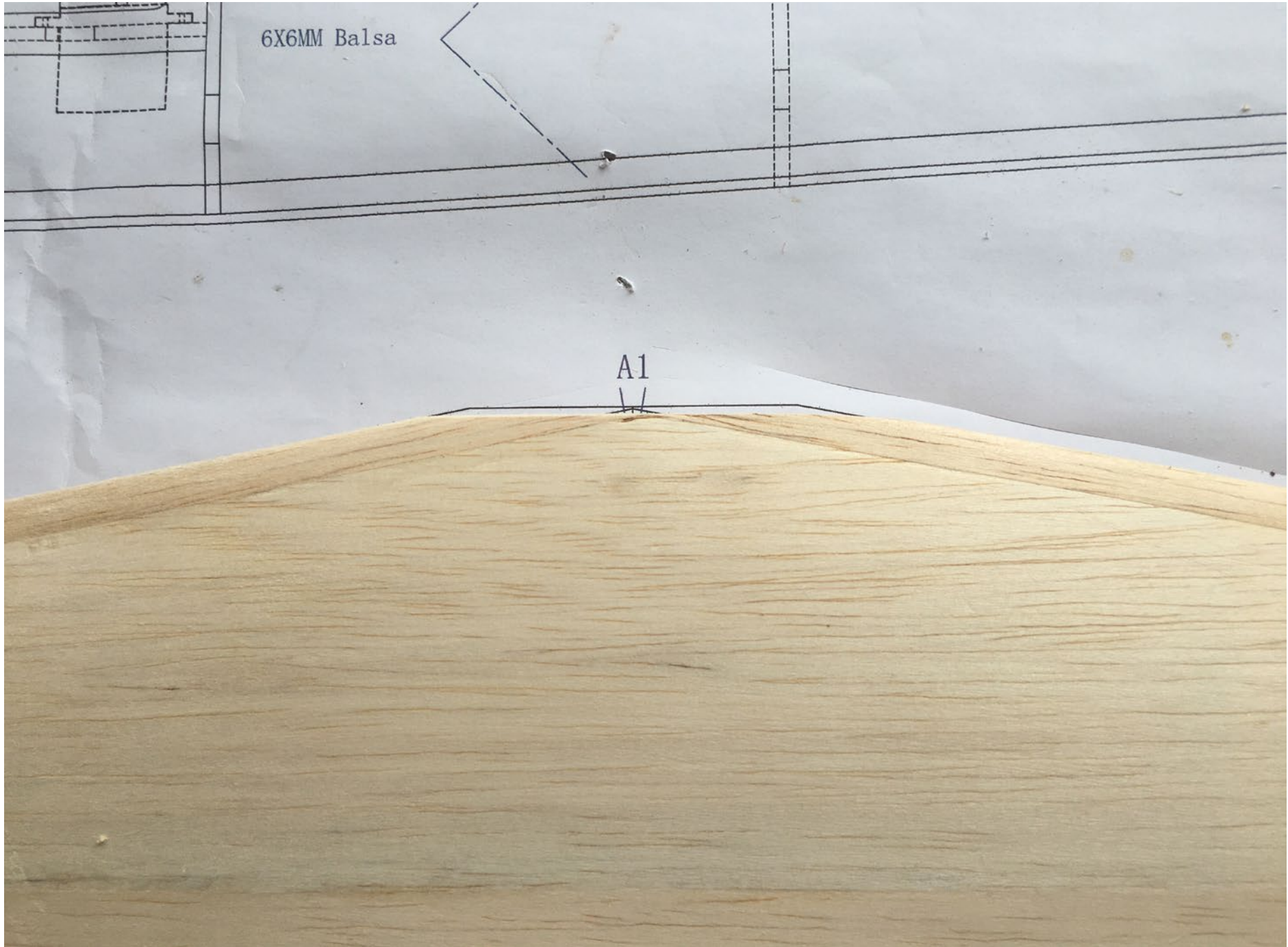

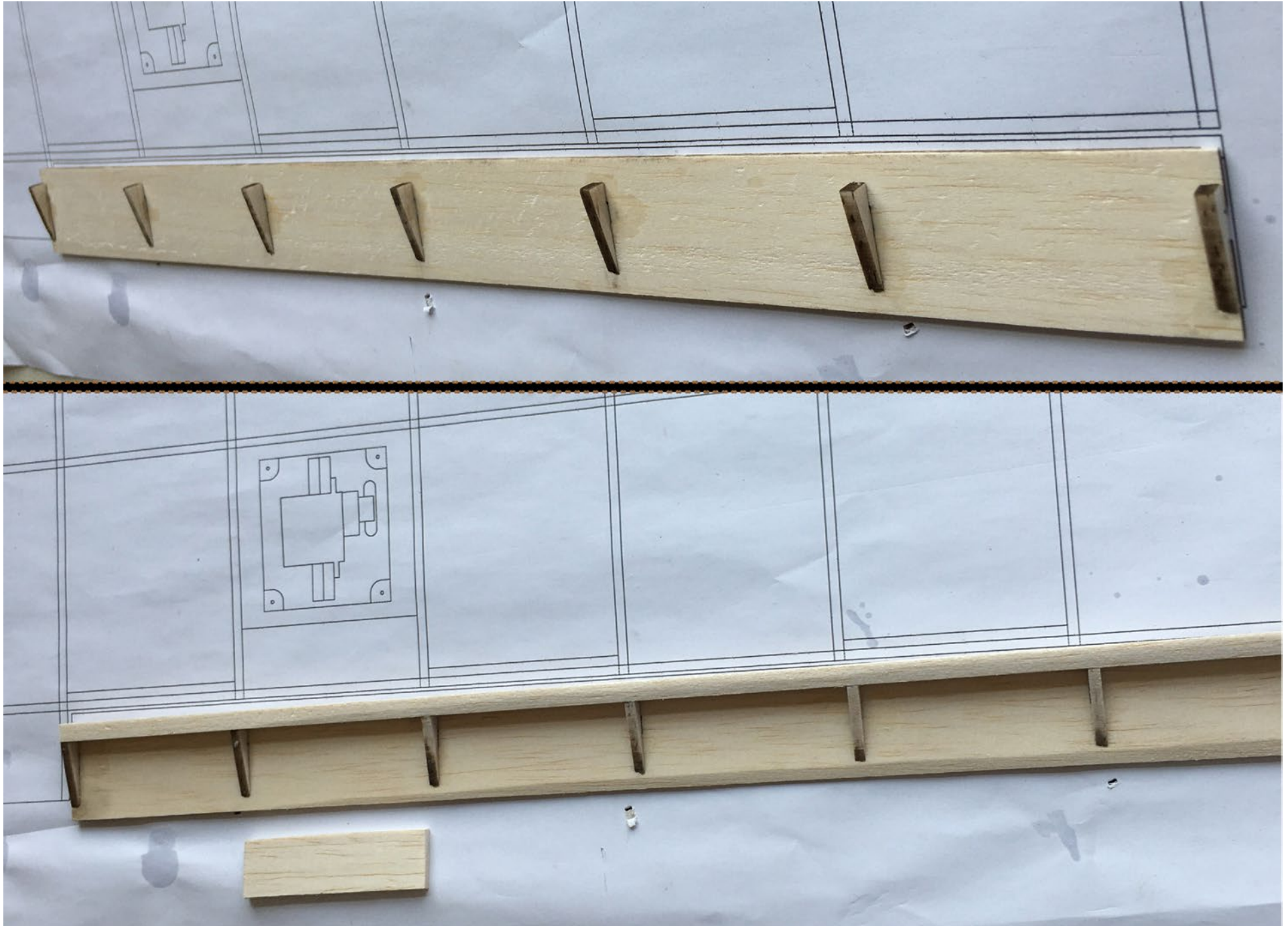

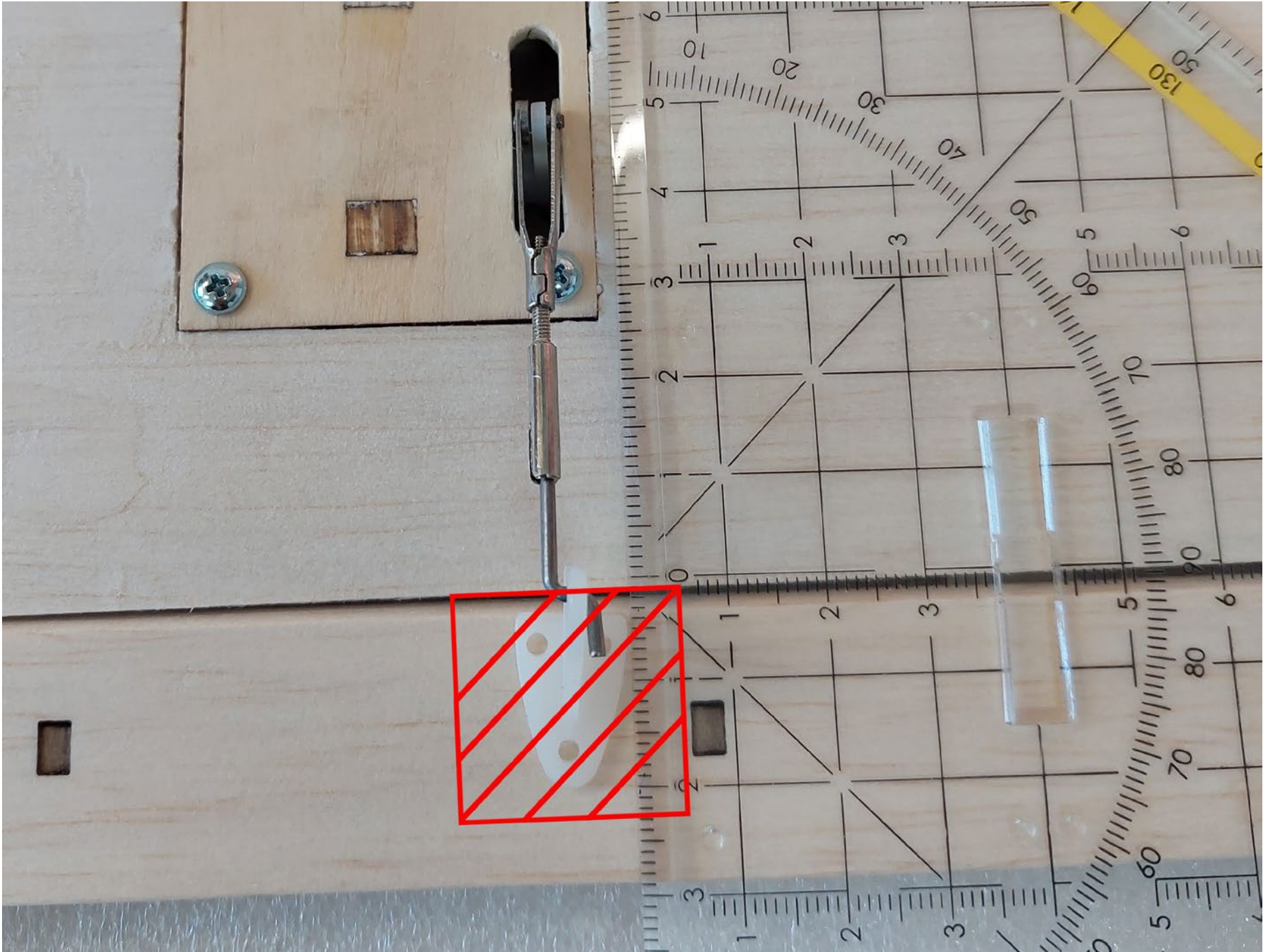

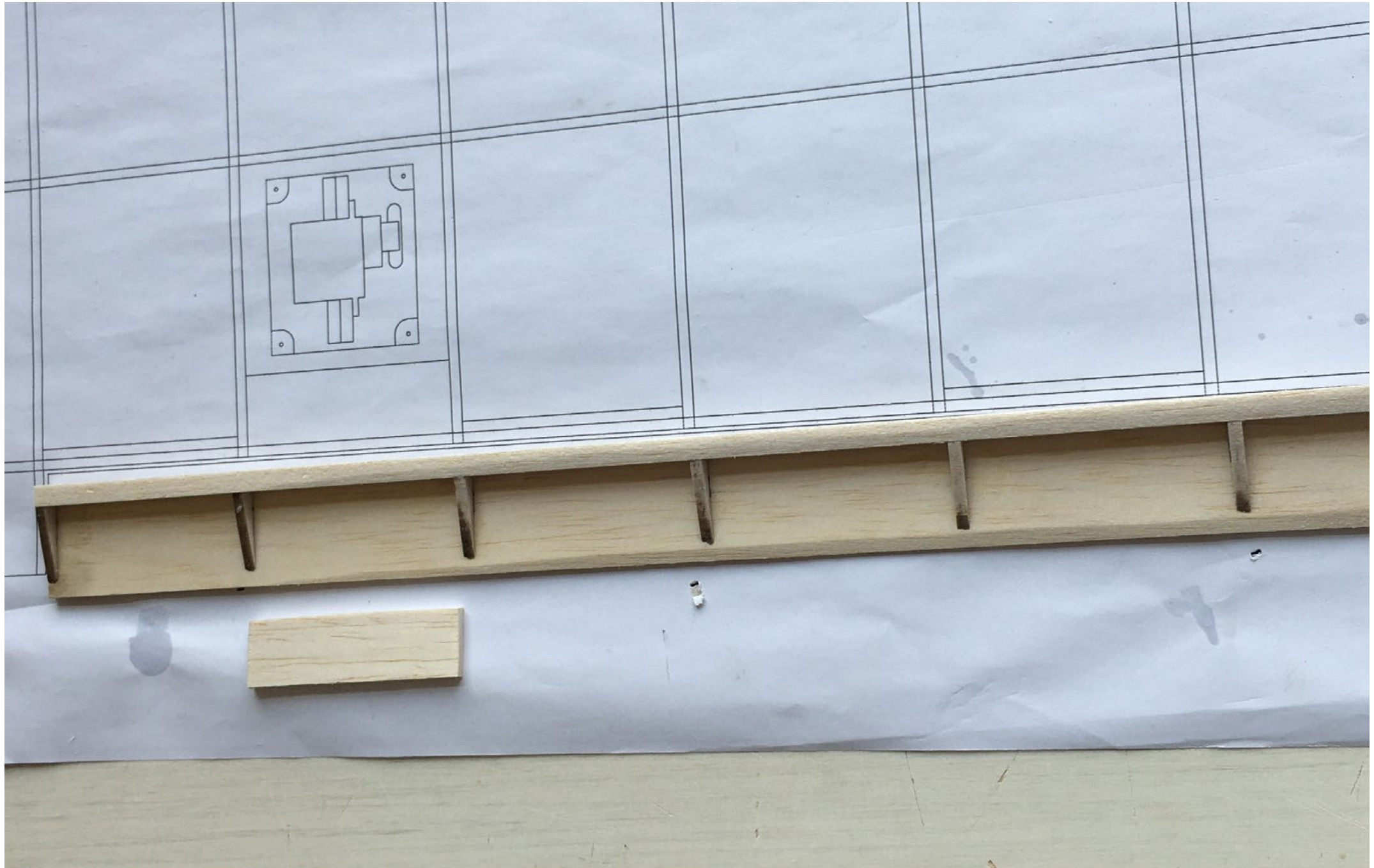





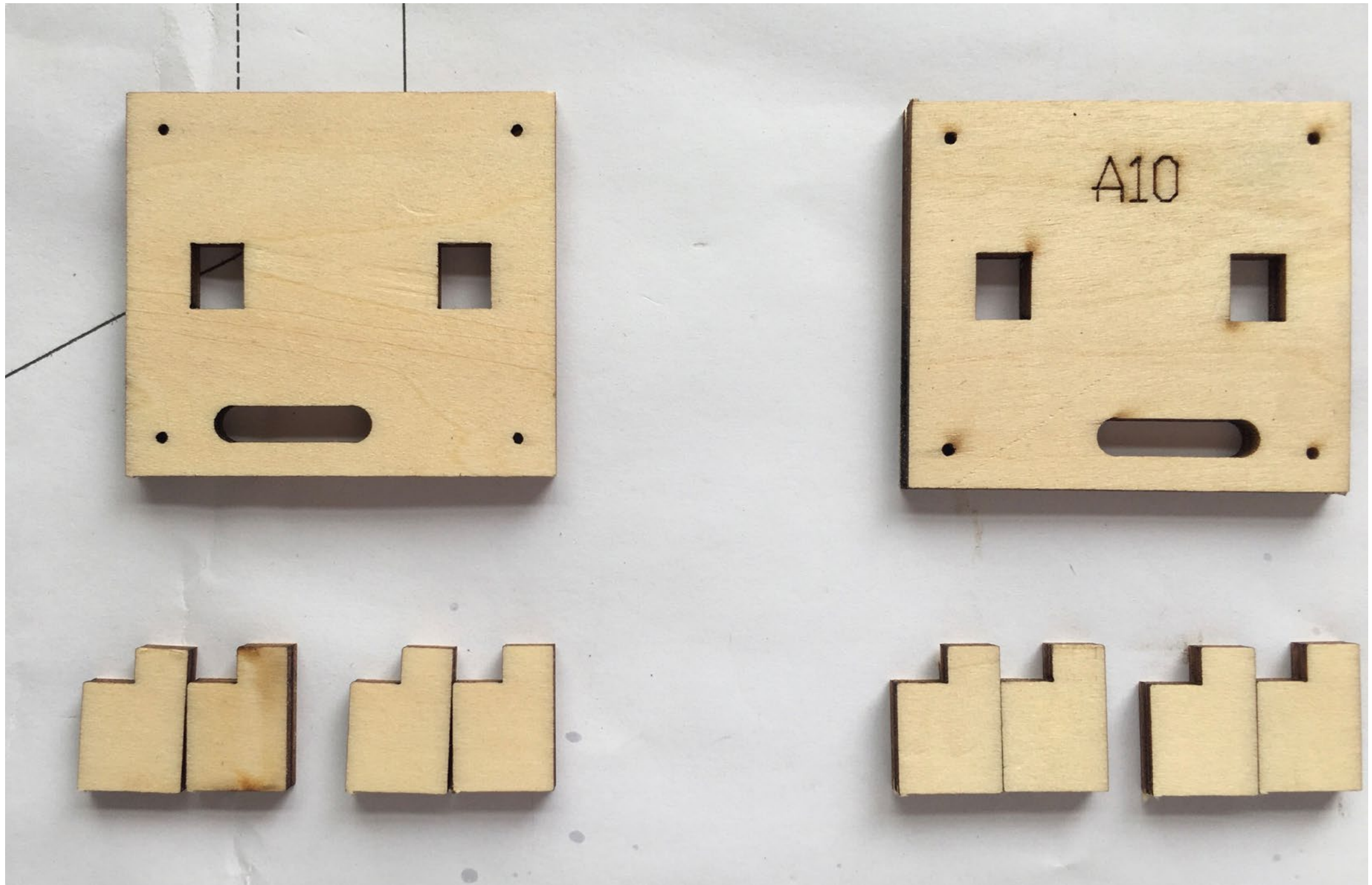

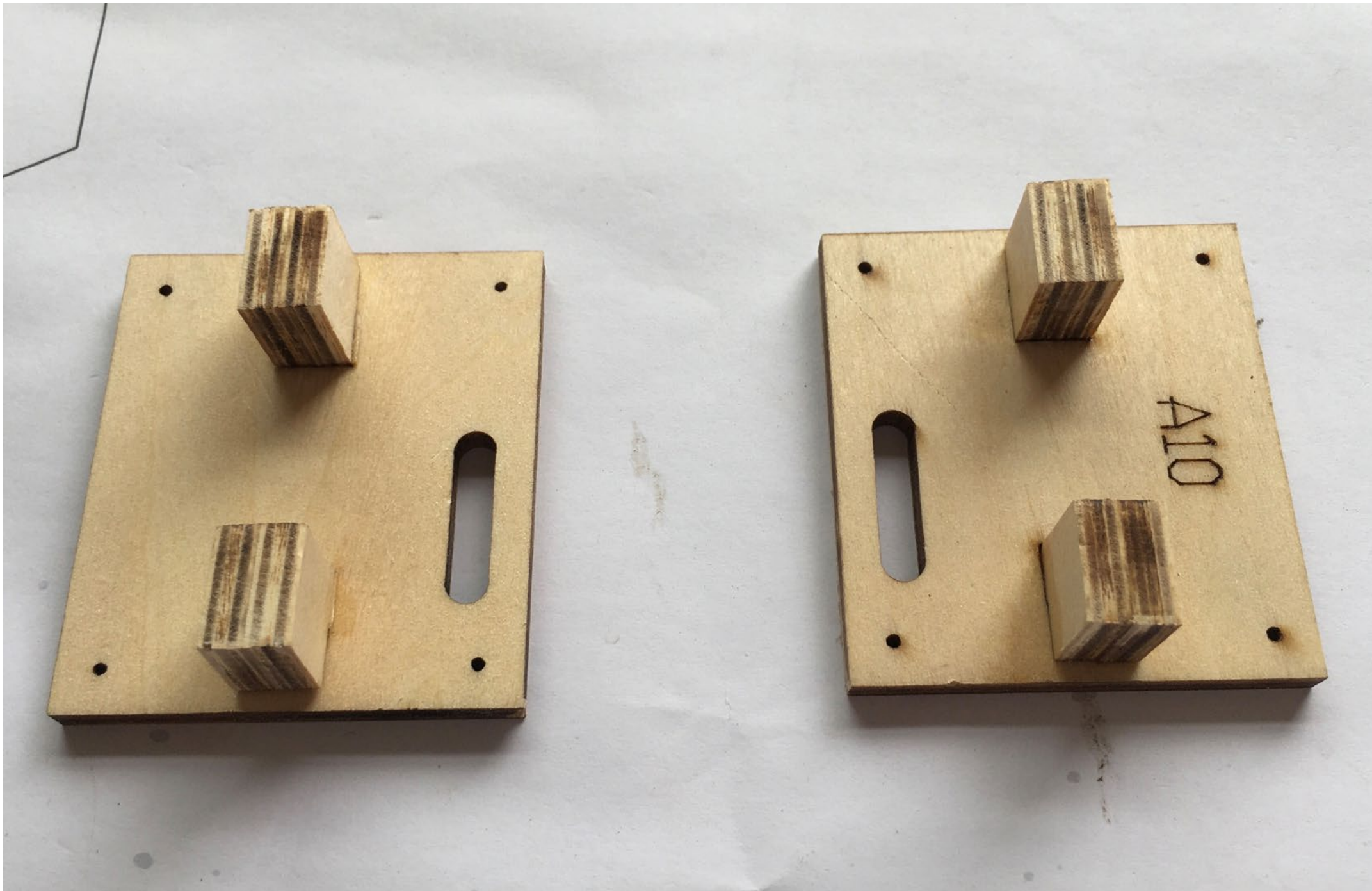



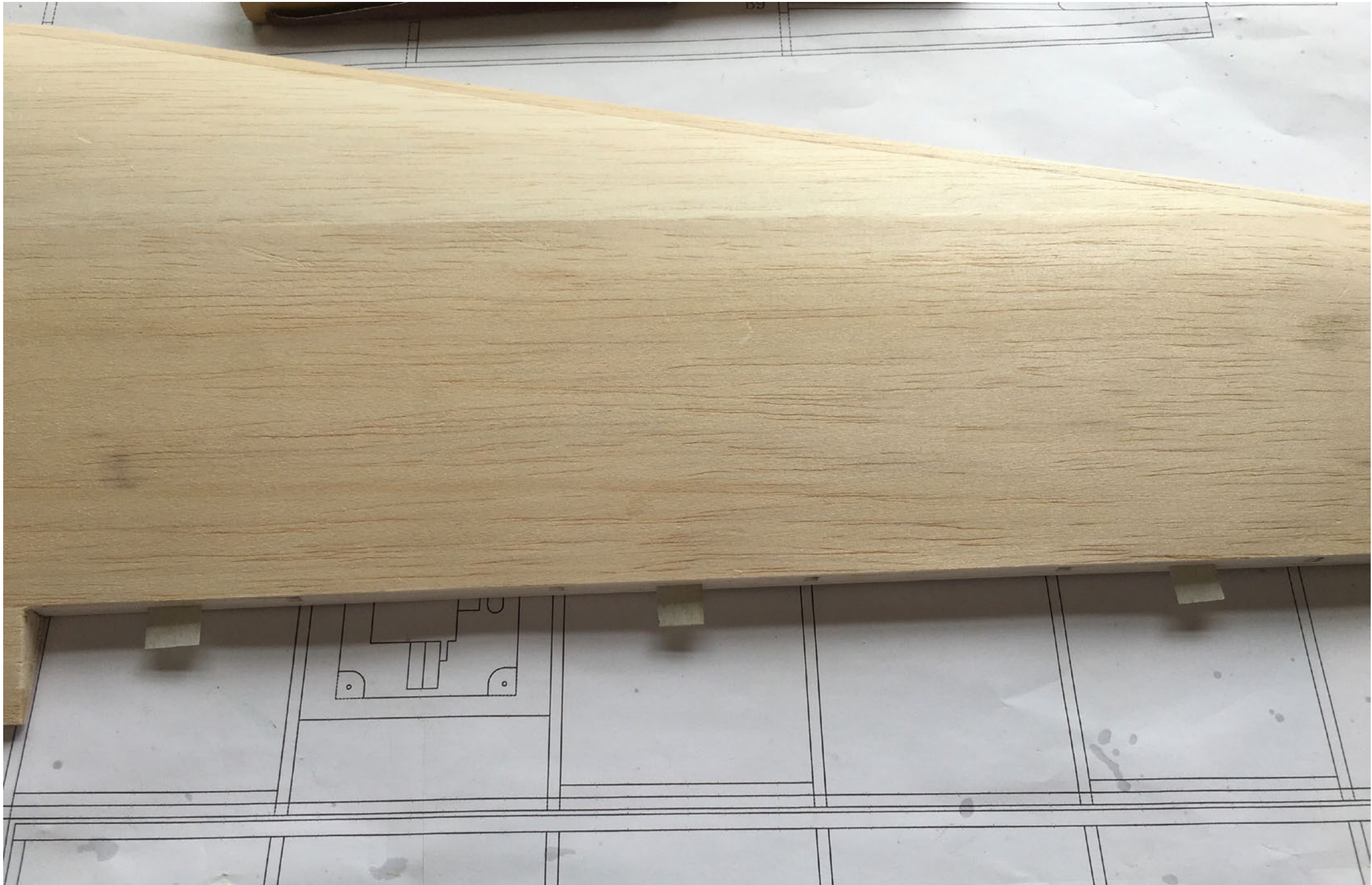









← robbe





← **robbe**

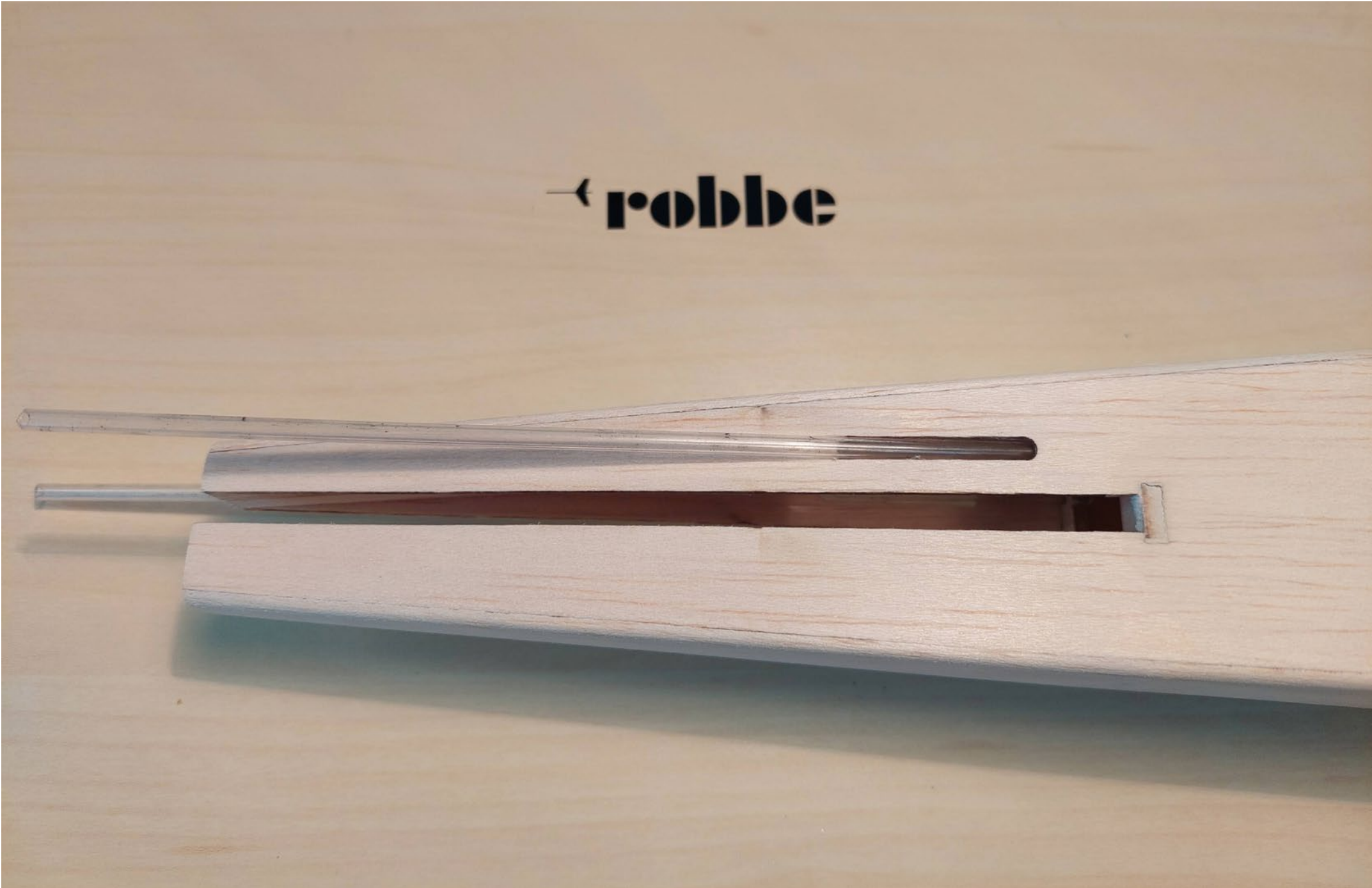



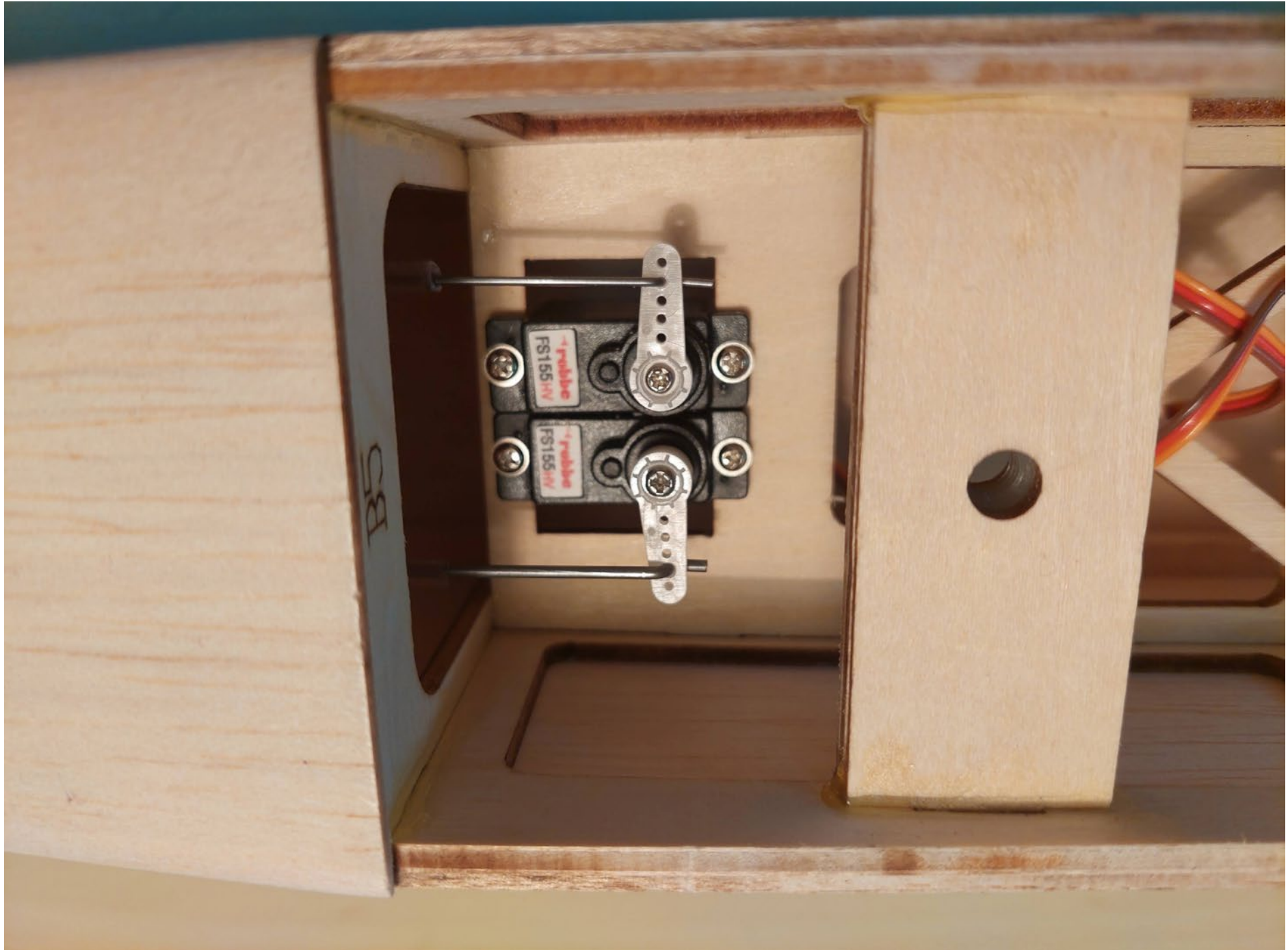



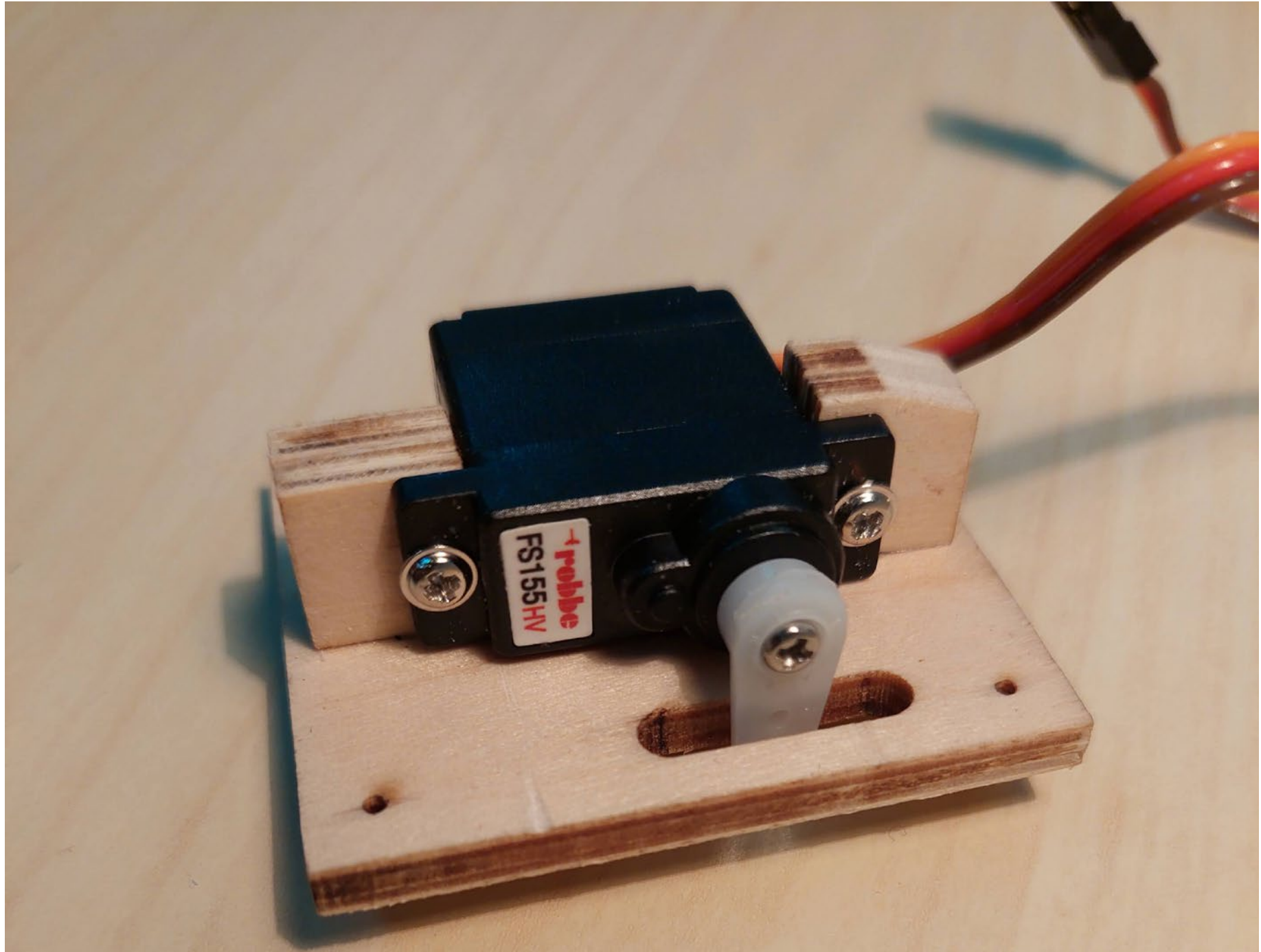

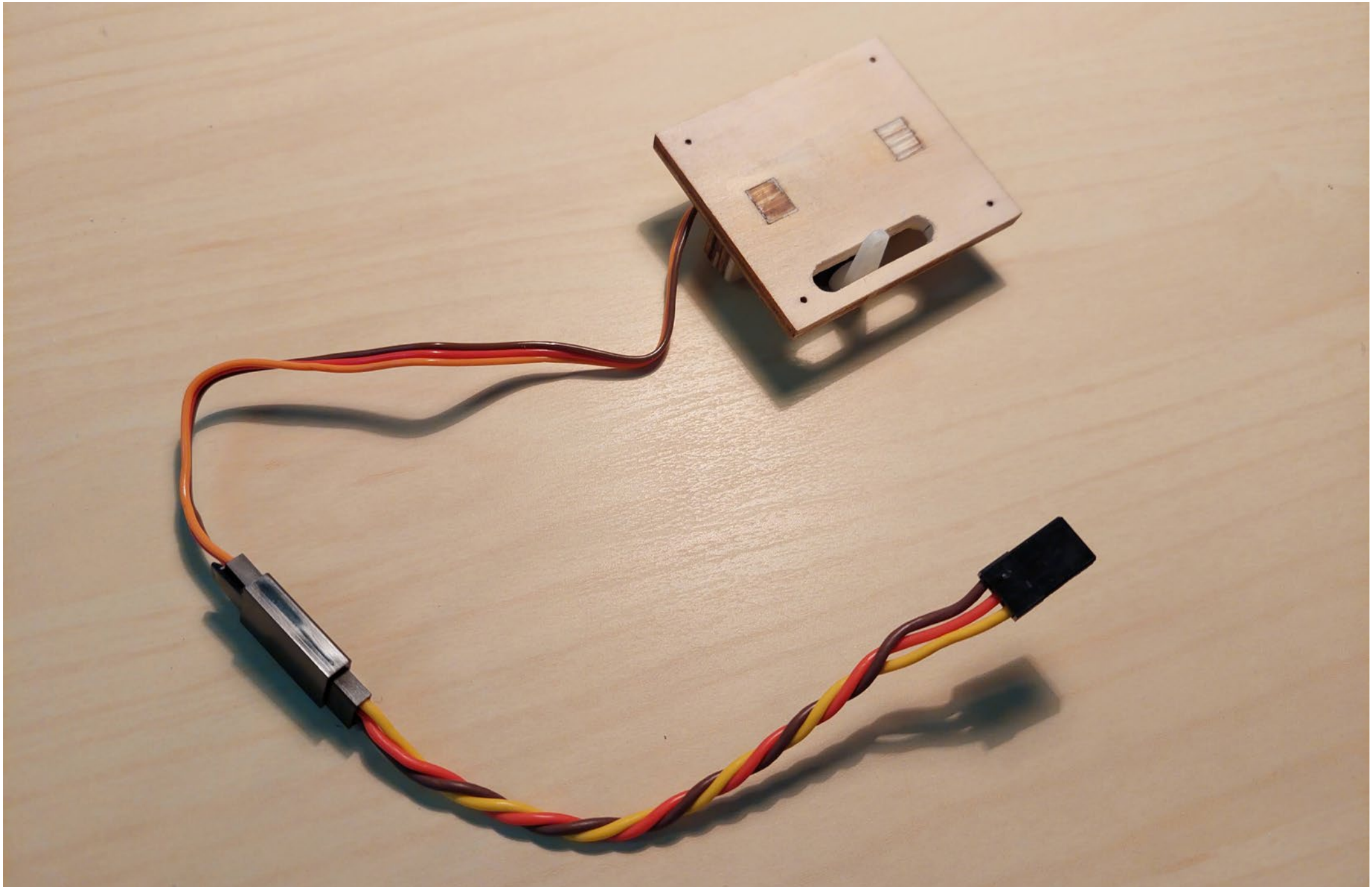



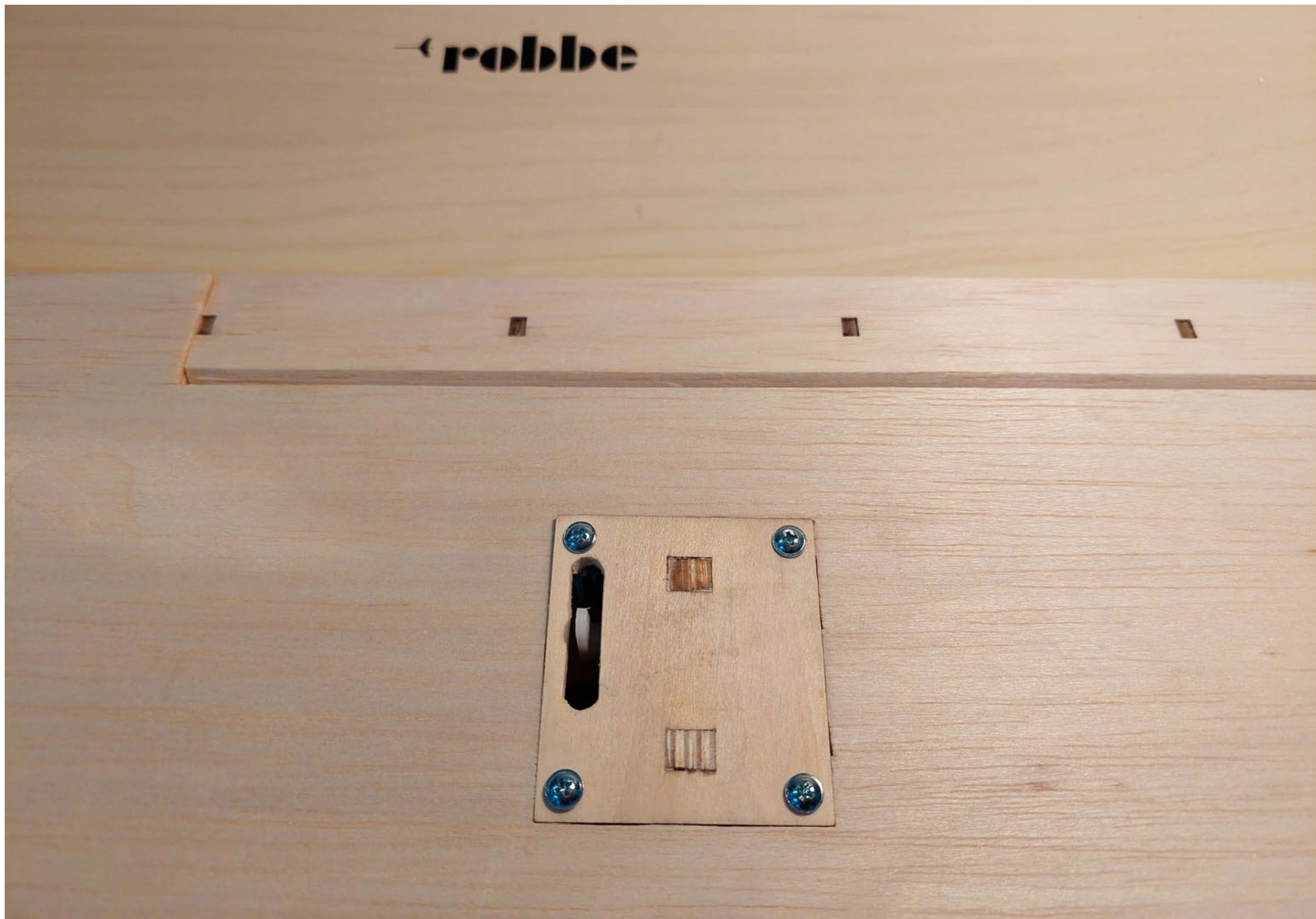

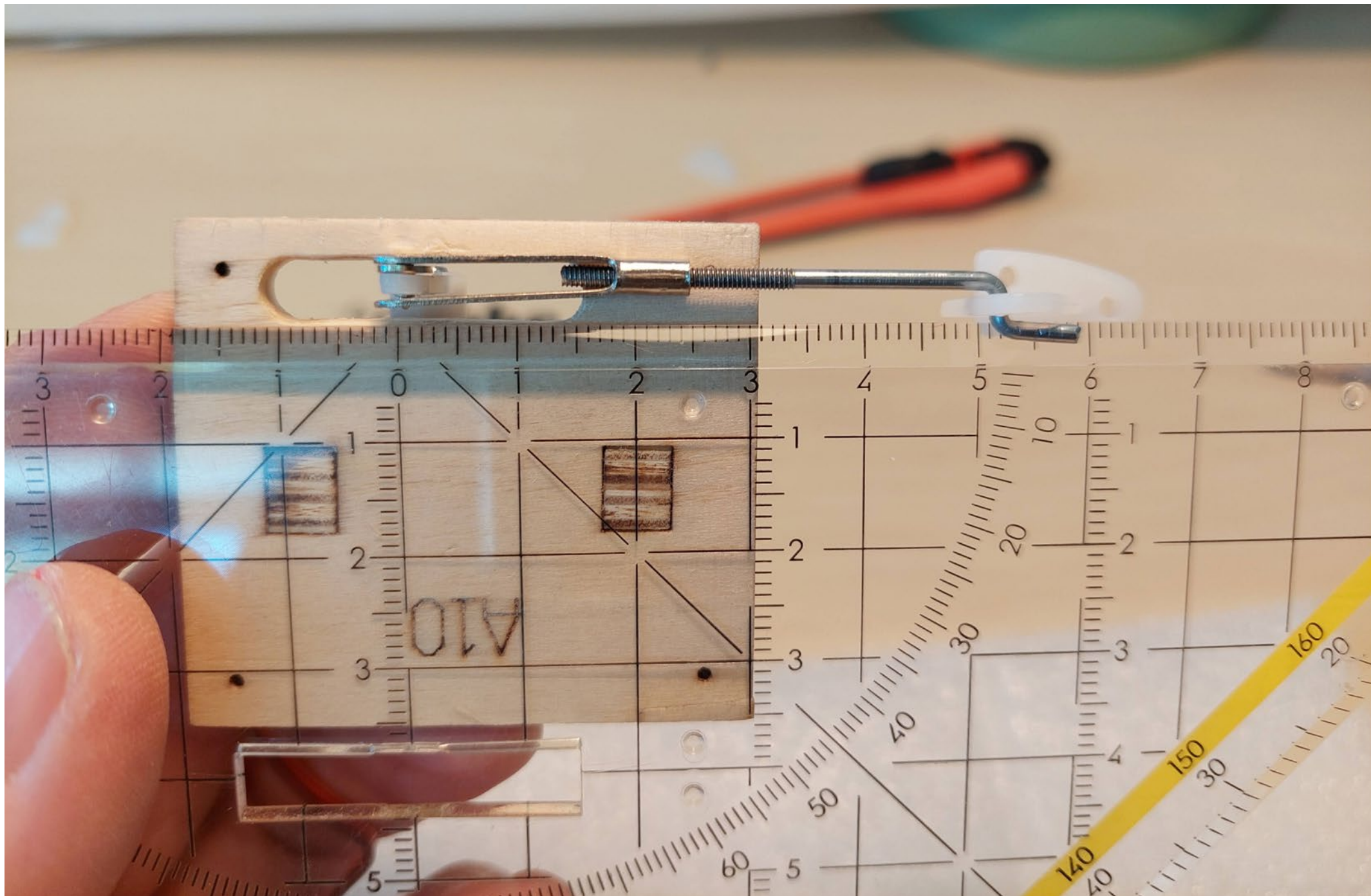

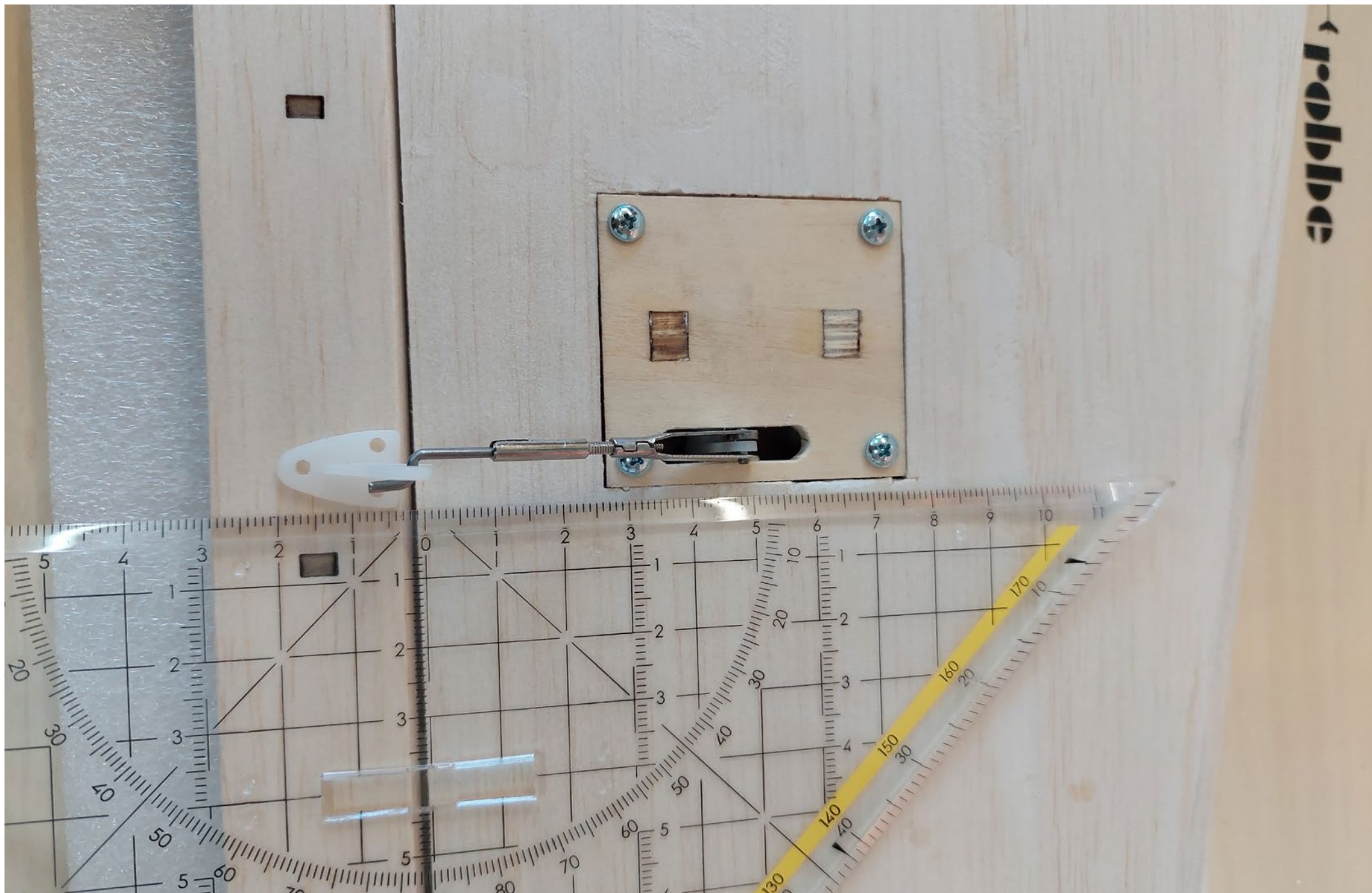



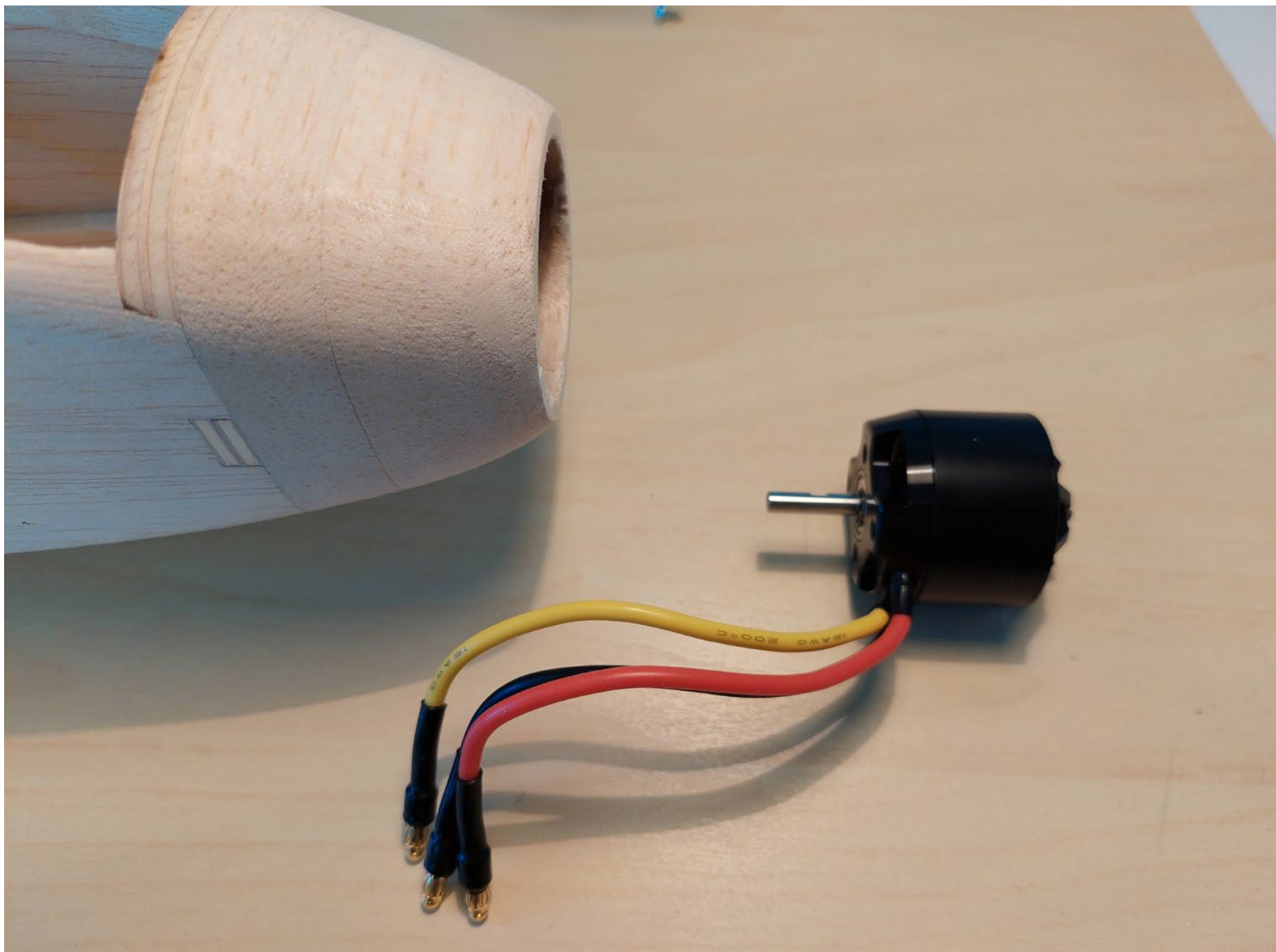

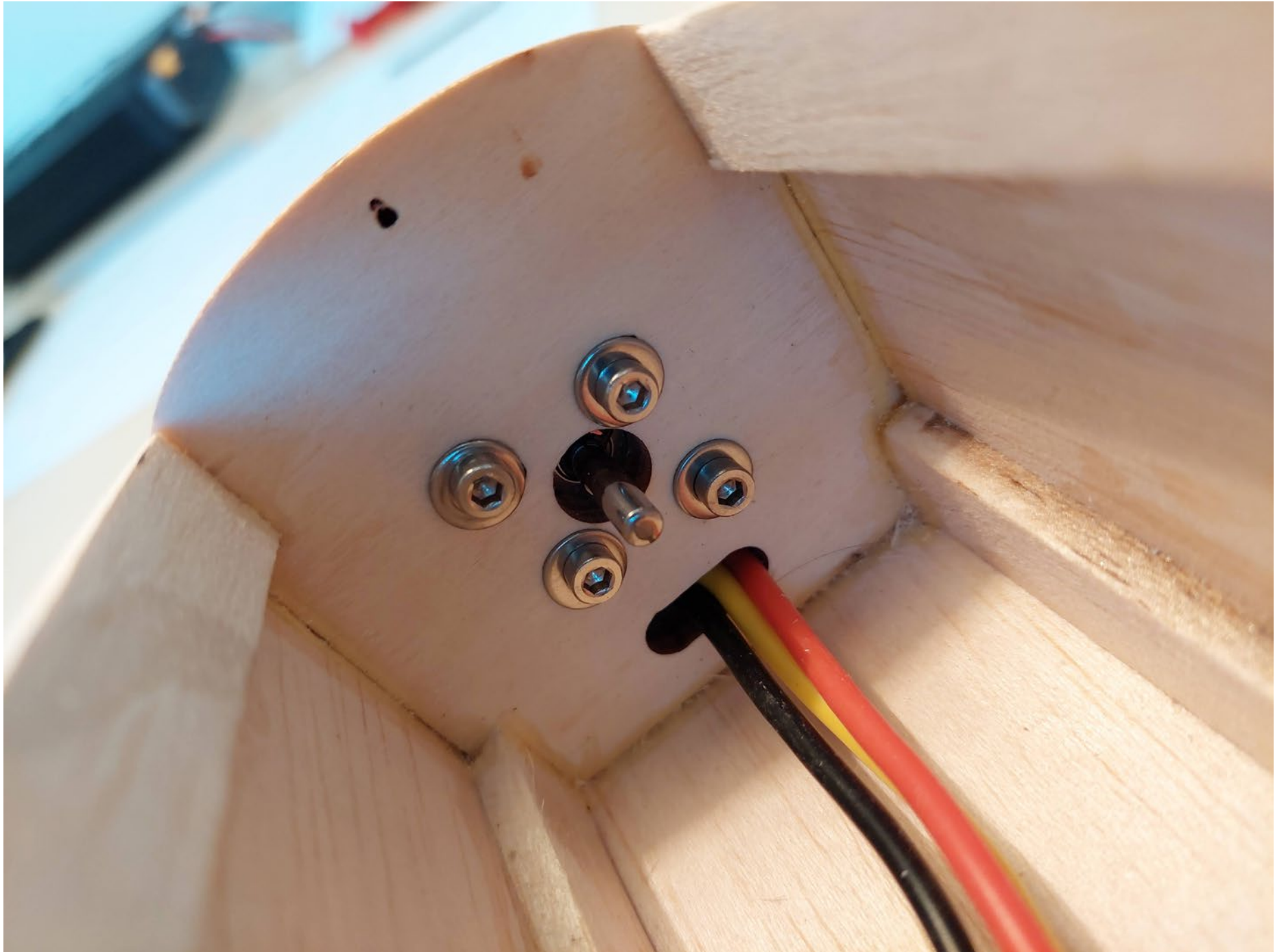



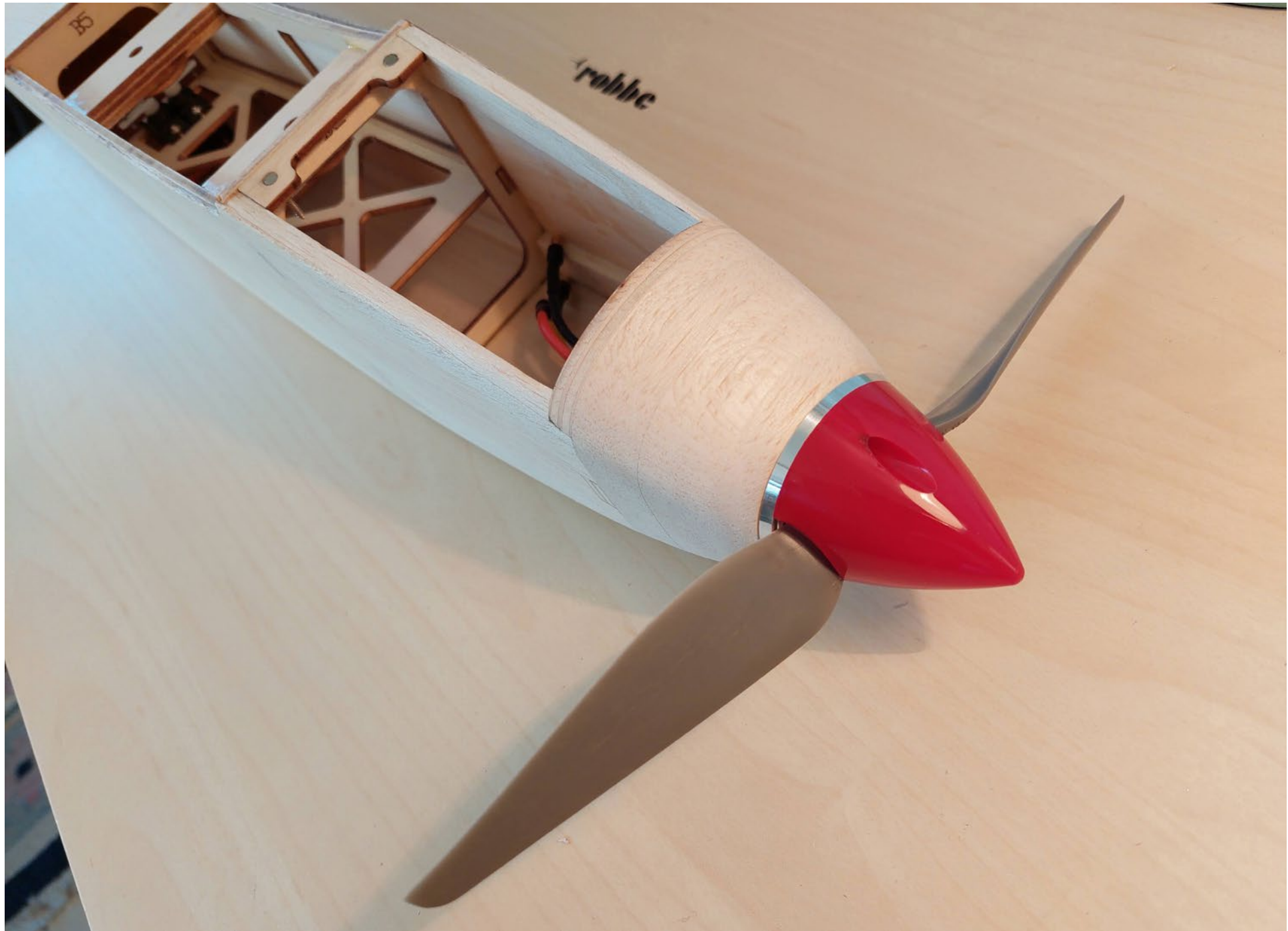



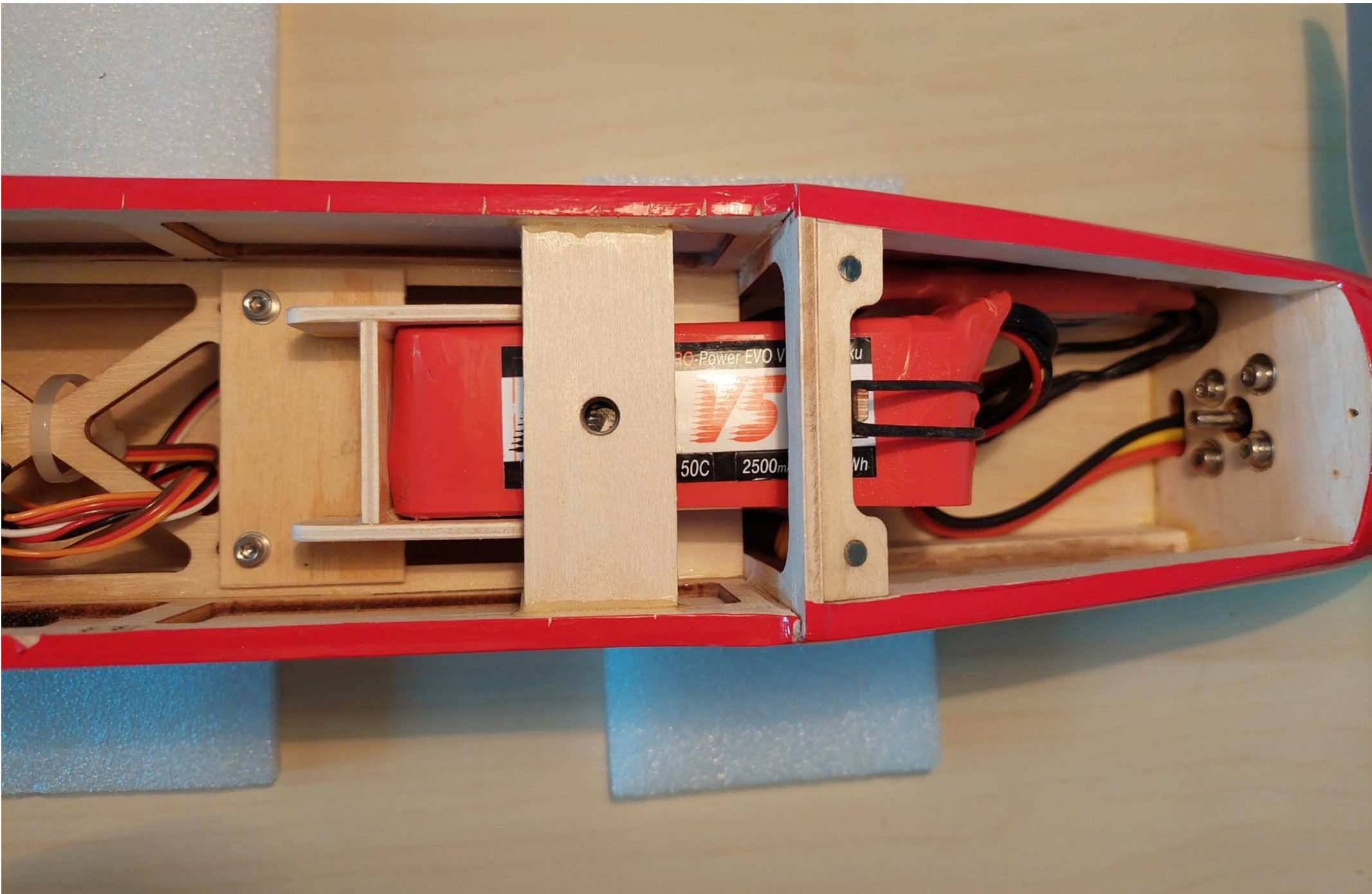



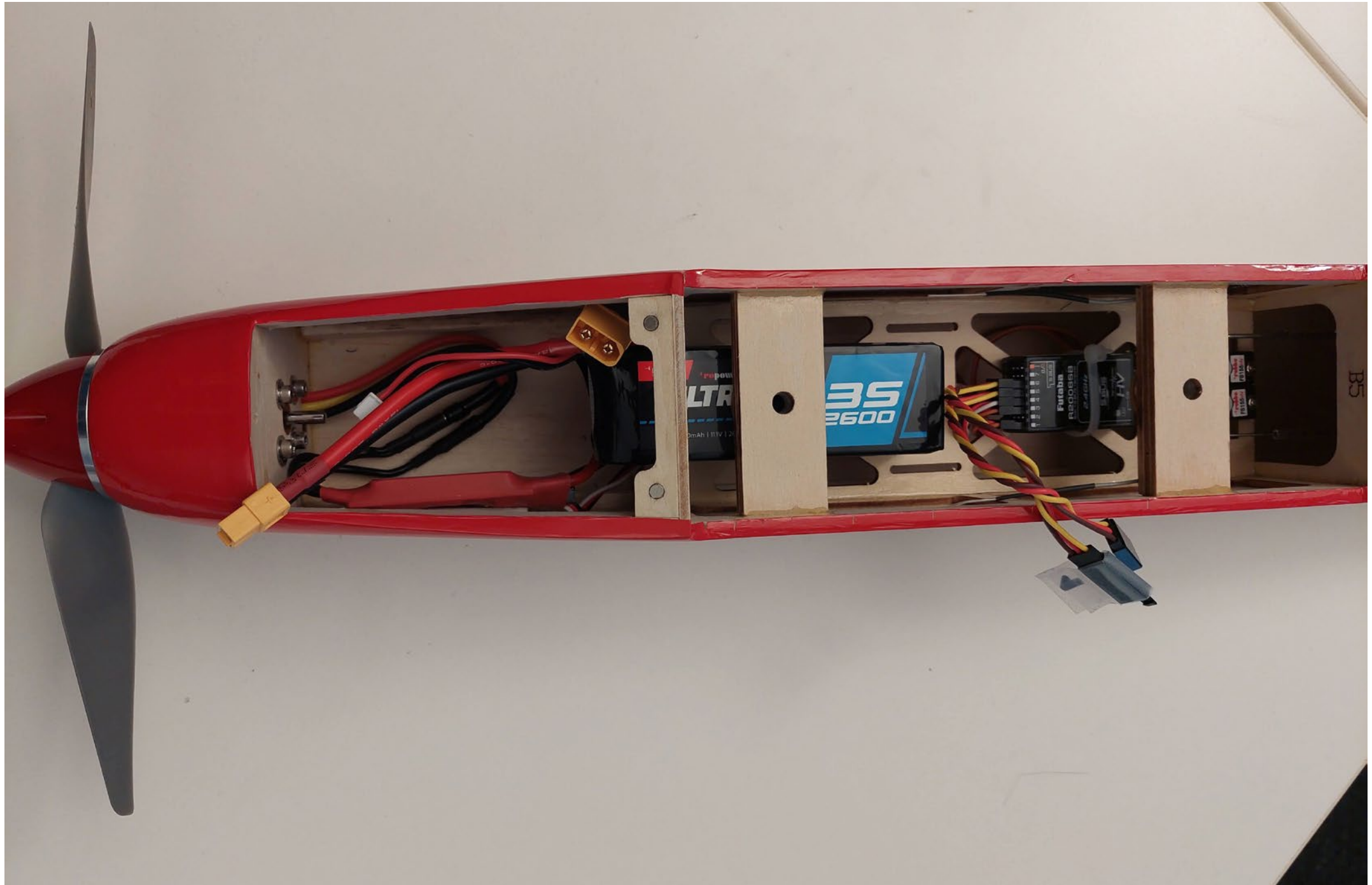



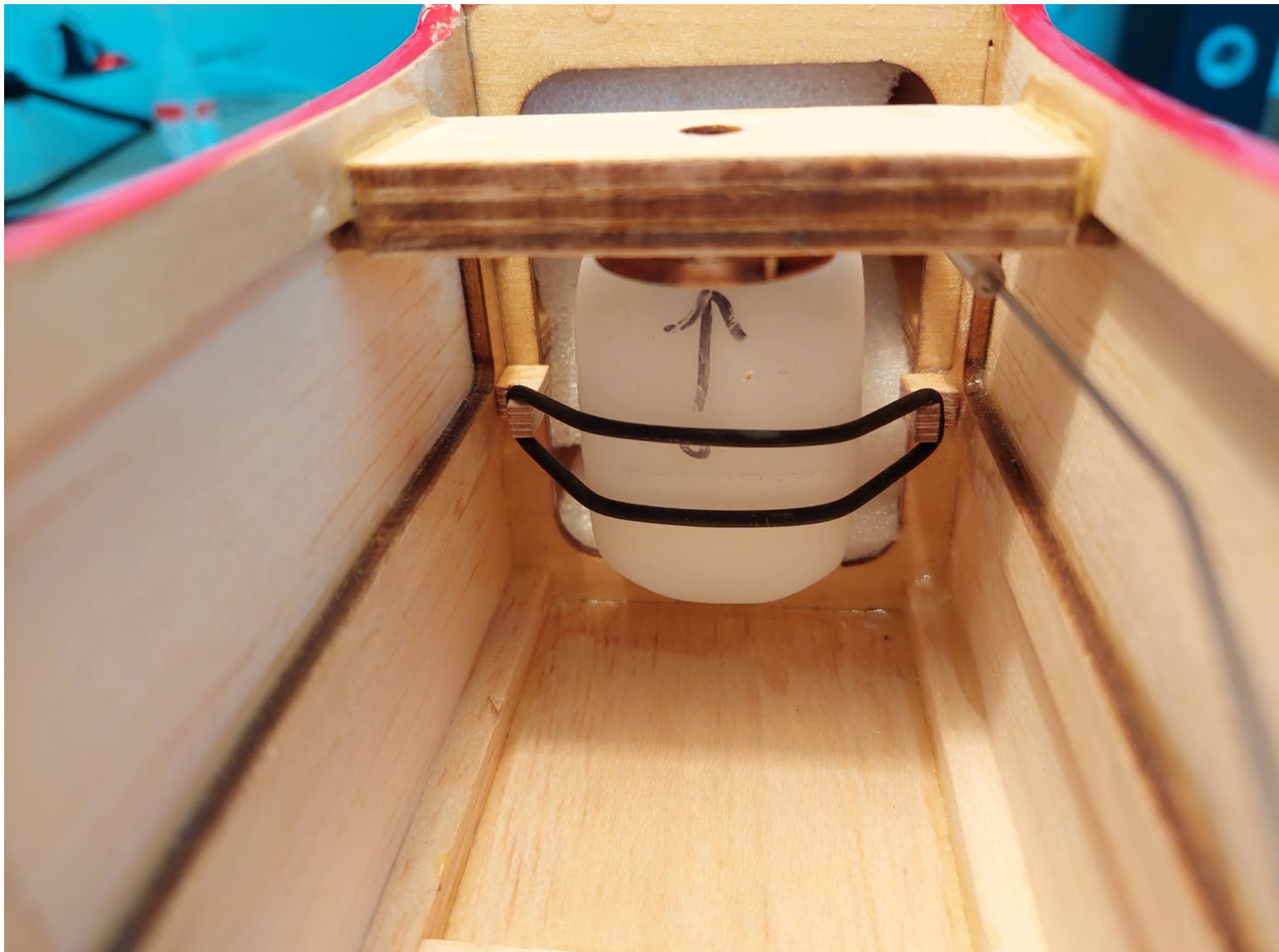



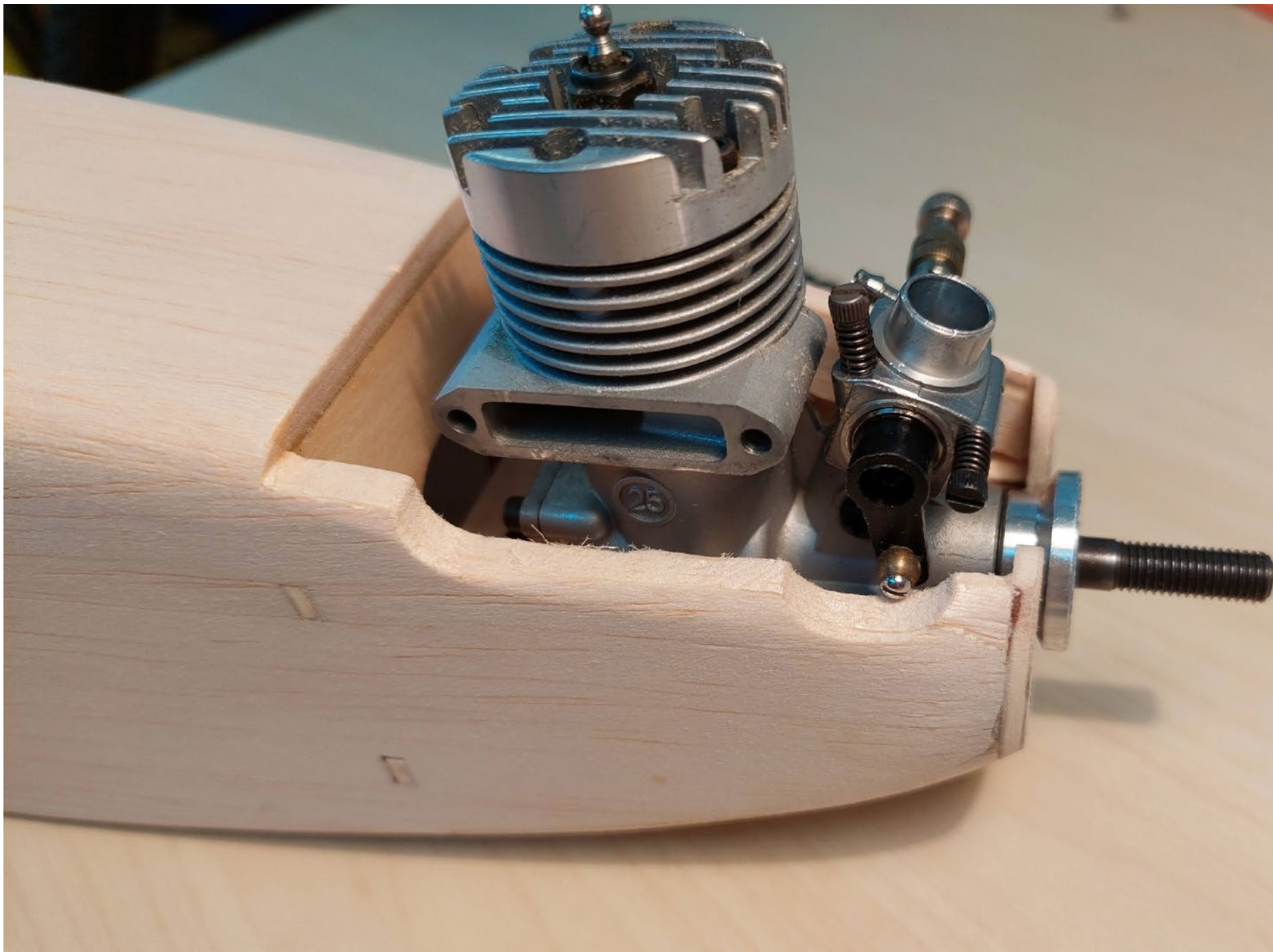

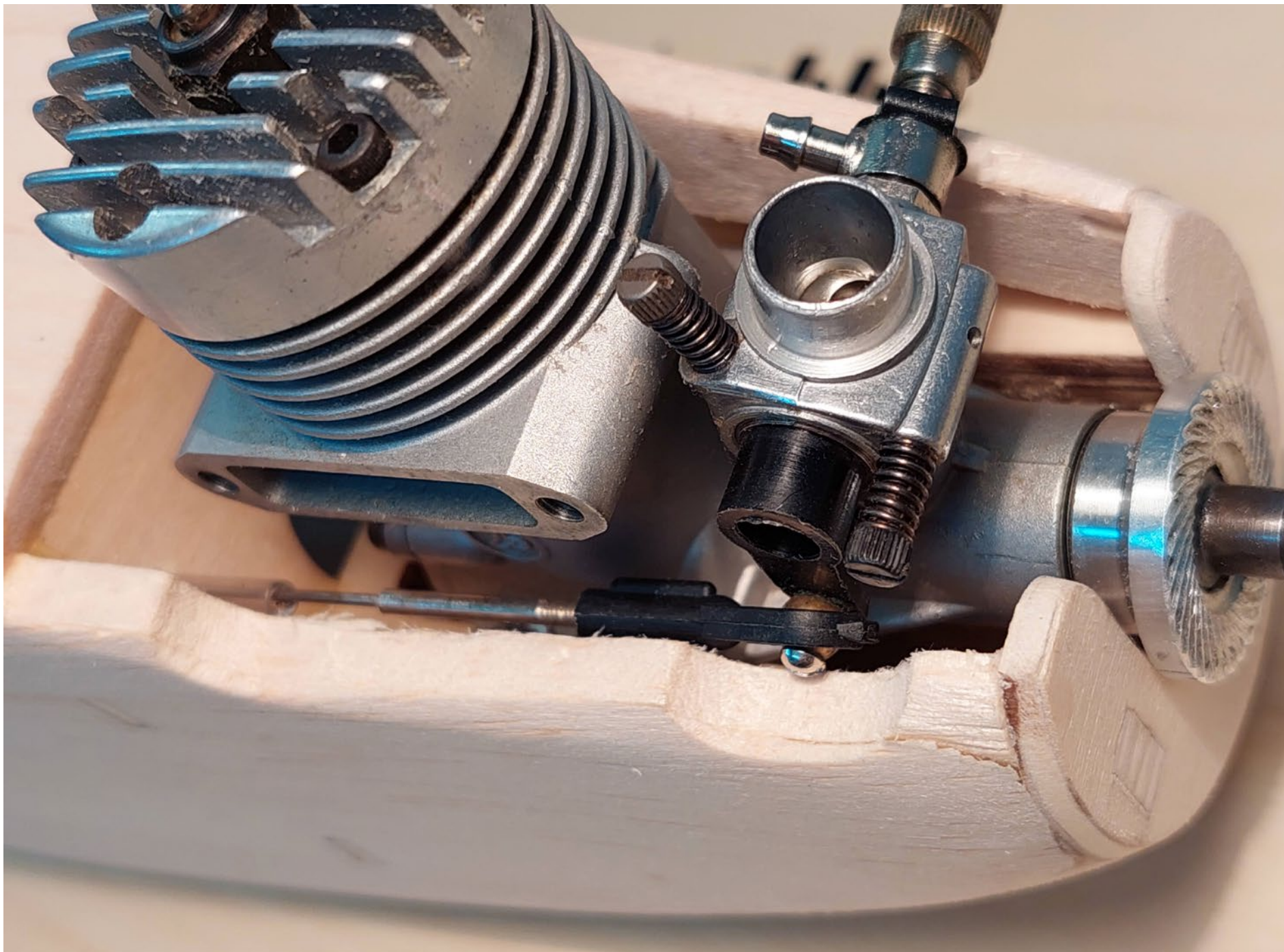

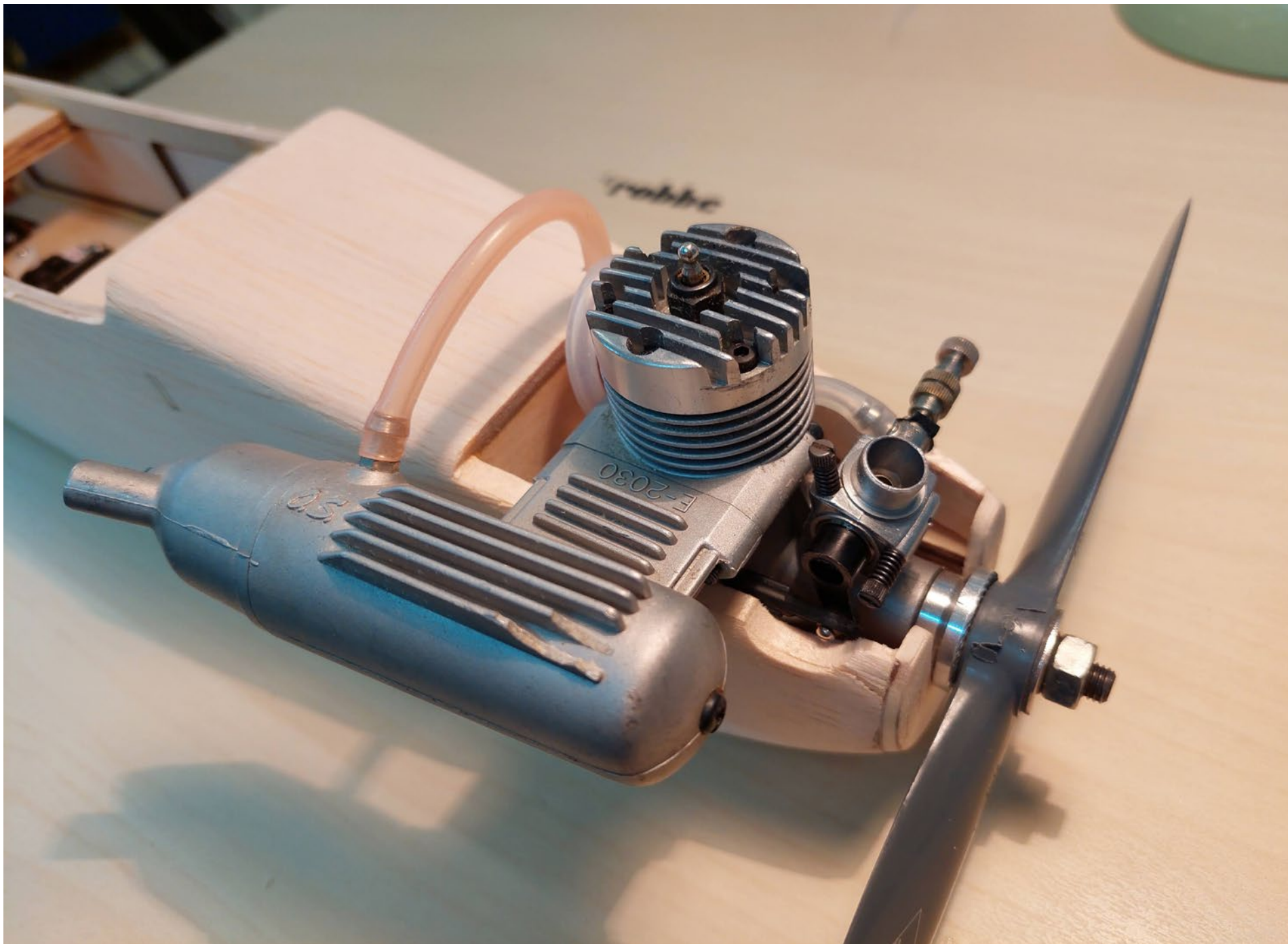







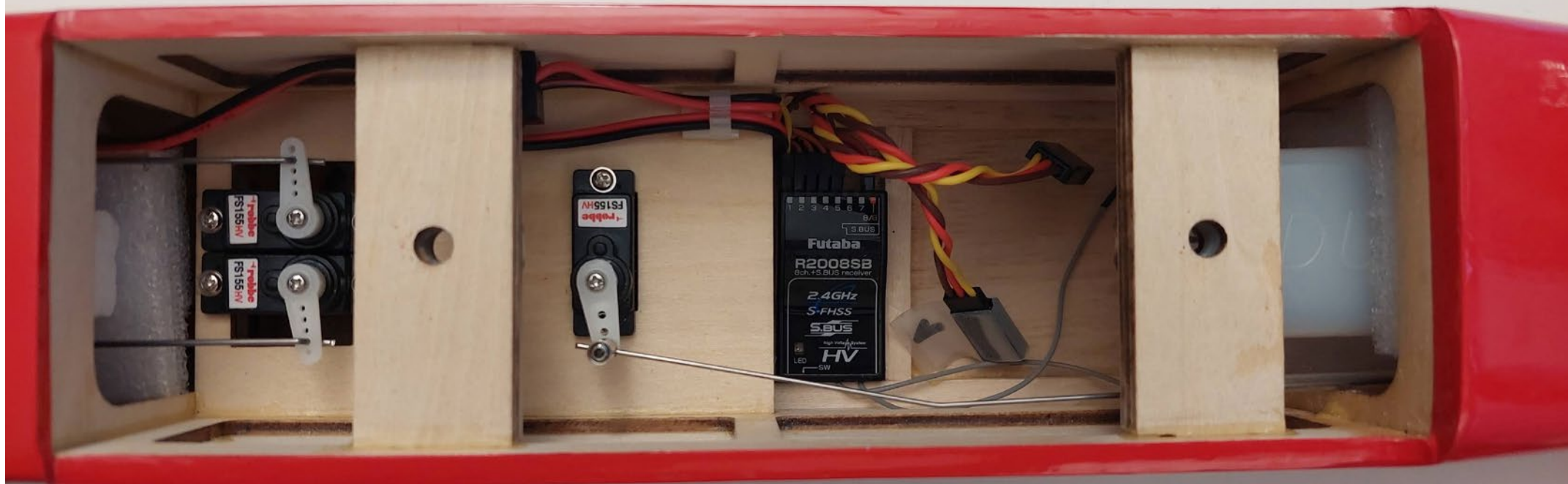

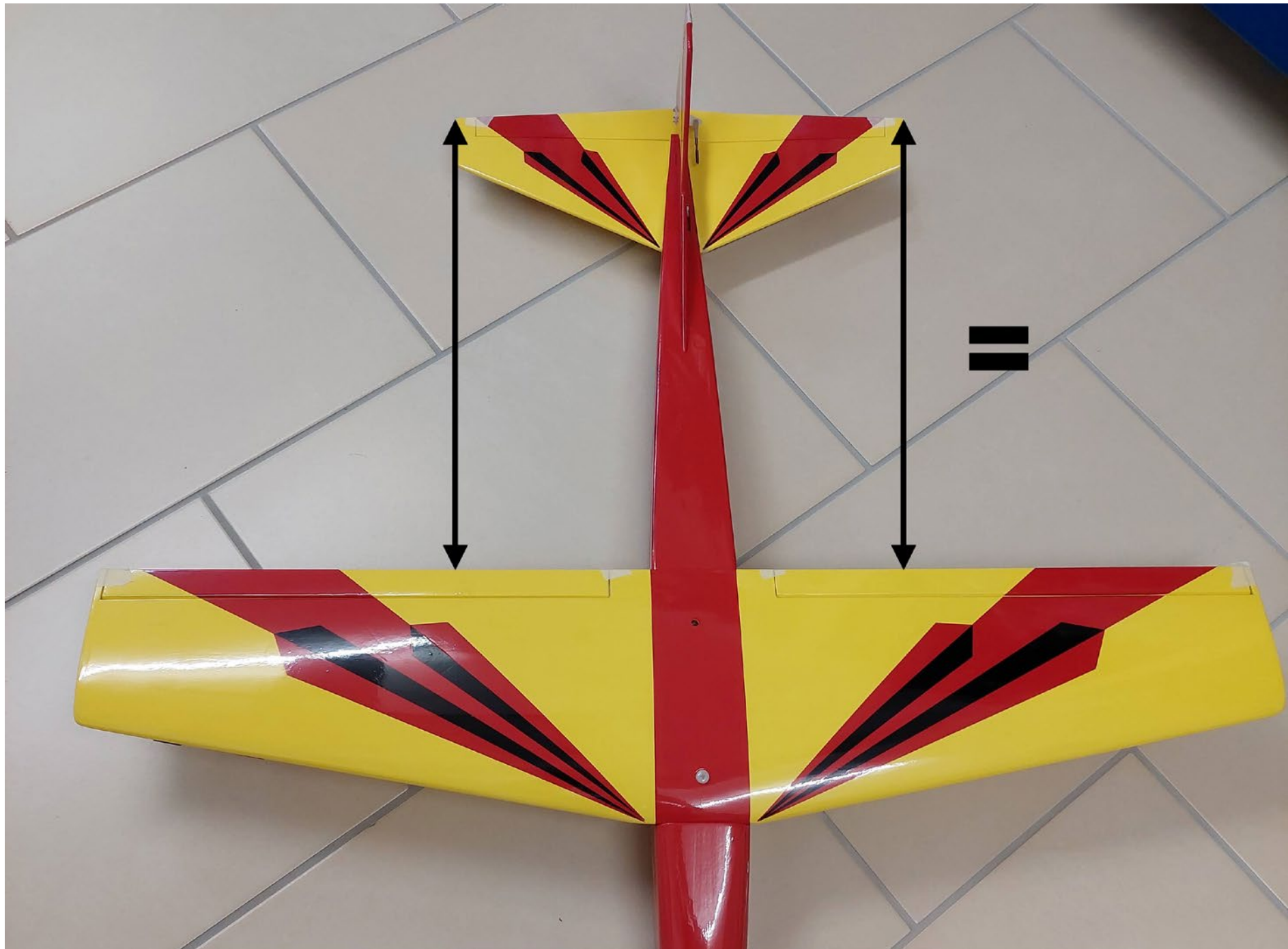

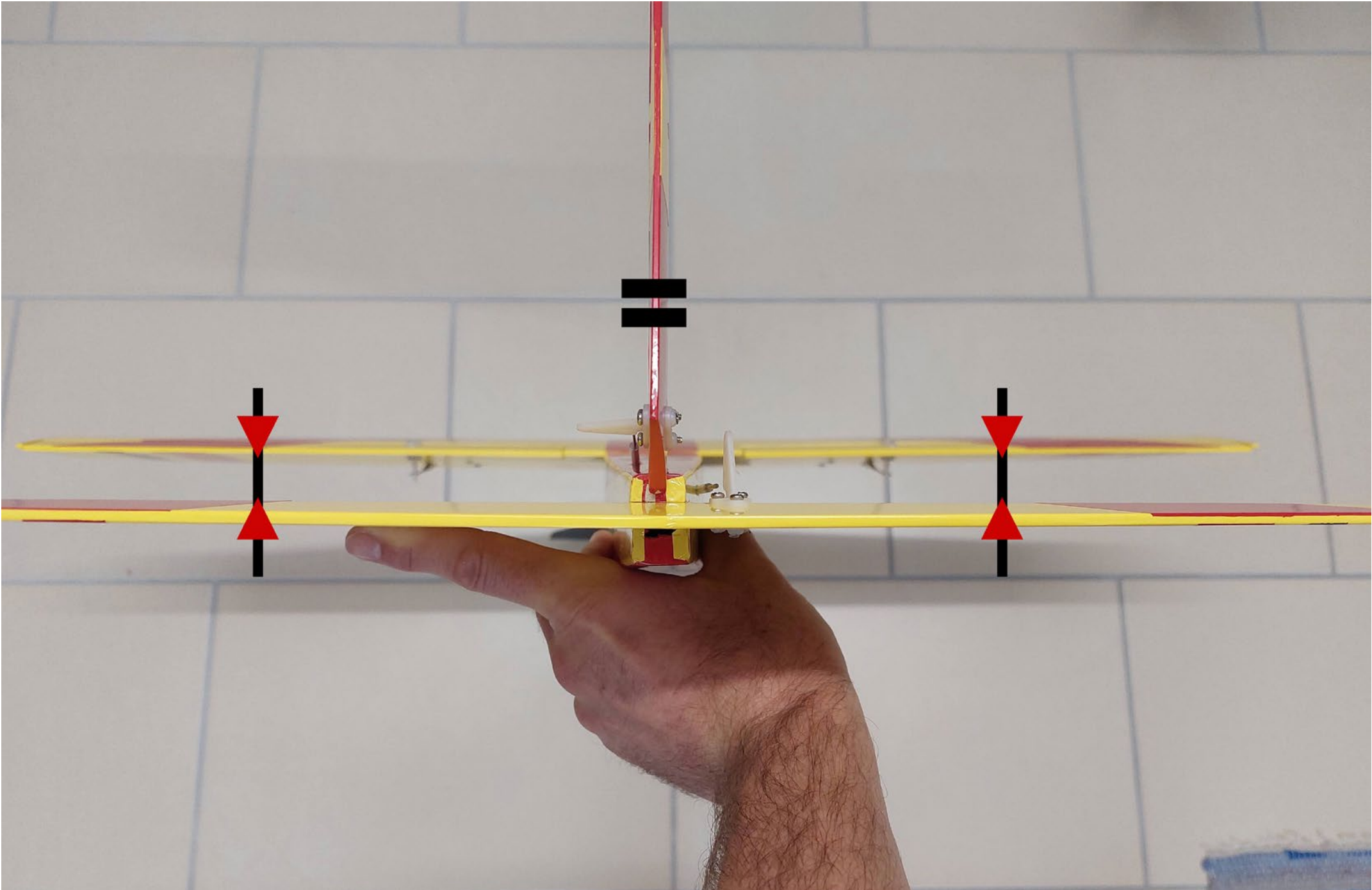
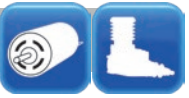

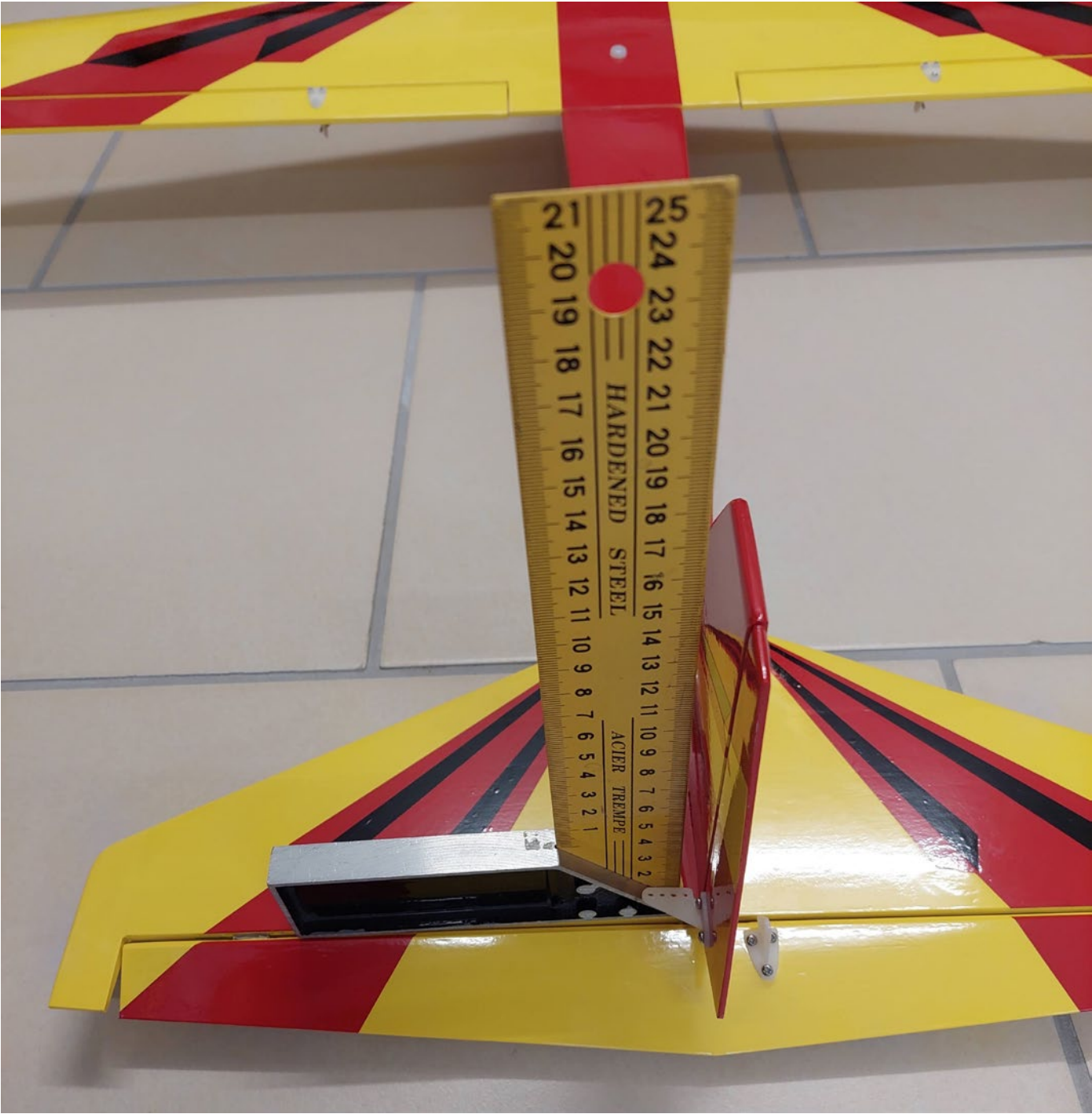
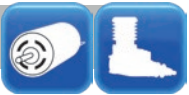



Rasant

→ **robbe Rasant**

→ **robbe Rasant**

→ **robbe**





Rudereinstellungen Rudder settings Réglages du gouvernail

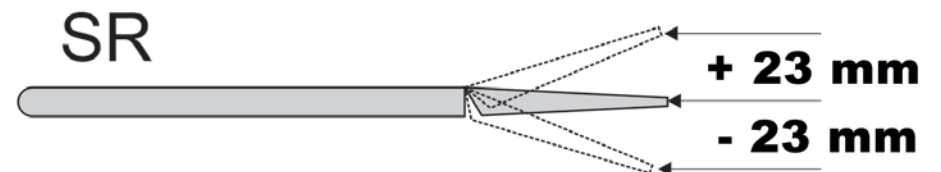
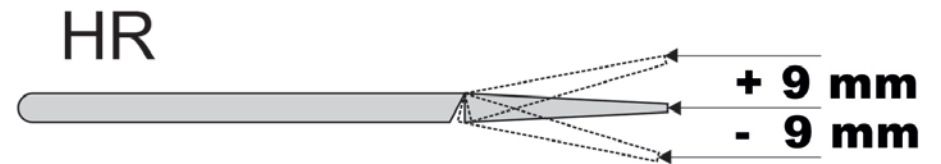
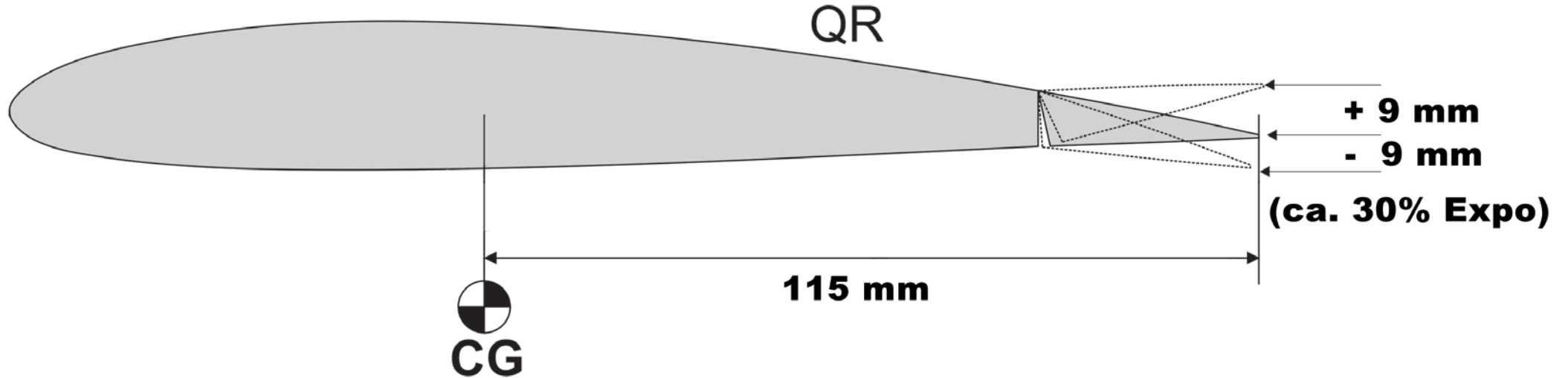



INVERKEHRBRINGER / DISTRIBUTOR / MISE SUR LE MARCHÉ

Robbe Modellsport

Industriestraße 10
4565 Inzersdorf im Kremstal Österreich
Telefon: +43(0)7582/81313-0
Mail: info@robbe.com
UID Nr.: ATU69266037

„robbe Modellsport“ ist eingetragenes
Markenzeichen.
Irrtum, Druckfehler und technische Änderun-
gen vorbehalten.

Copyright 2021

Robbe Modellsport 2021
Kopie und Nachdruck, auch
auszugsweise, nur mit
schriftlicher Genehmigung.

Service-Adresse

Über Ihren Fachhändler oder:
Robbe Modellsport, Industriestraße 10,
4565 Inzersdorf im Kremstal
service@robbe.com +43(0)7582-81313-0

Robbe Modellsport

Industriestraße 10
4565 Inzersdorf im Kremstal Austria
Phone: +43(0)7582/81313-0
Mail: info@robbe.com
UID No.: ATU69266037

„robbe Modellsport“ is a registered
Trademark.
Errors, misprints and technical changes
reserved.

Copyright 2021

Robbe Modellsport 2021
Copy and reprint only
with our permission.

Service-Address

Contact your Dealer or:
Robbe Modellsport, Industriestraße 10,
4565 Inzersdorf im Kremstal
service@robbe.com, +43(0)7582-81313-0

Robbe Modellsport

Industriestraße 10
4565 Inzersdorf im Kremstal Autriche
Téléphone: +43(0)7582/81313-0
Email: info@robbe.com
UID Nr.: ATU69266037

„robbe Modellsport“ est une marque
déposée.
Sous réserve d'erreurs, de fautes d'impression
et de modifications techniques.

Copyright 2021

Robbe Modellsport 2021
Copie et réimpression, même partielle,
uniquement avec autorisation écrite.

Service

Par l'intermédiaire de votre revendeur
spécialisé ou :
Robbe Modellsport, Industriestraße 10,
4565 Inzersdorf im Kremstal
service@robbe.com, +43 7582-81313-0



Made in China

+14